

# Los Angeles Approved Commercial Spa Models 2024

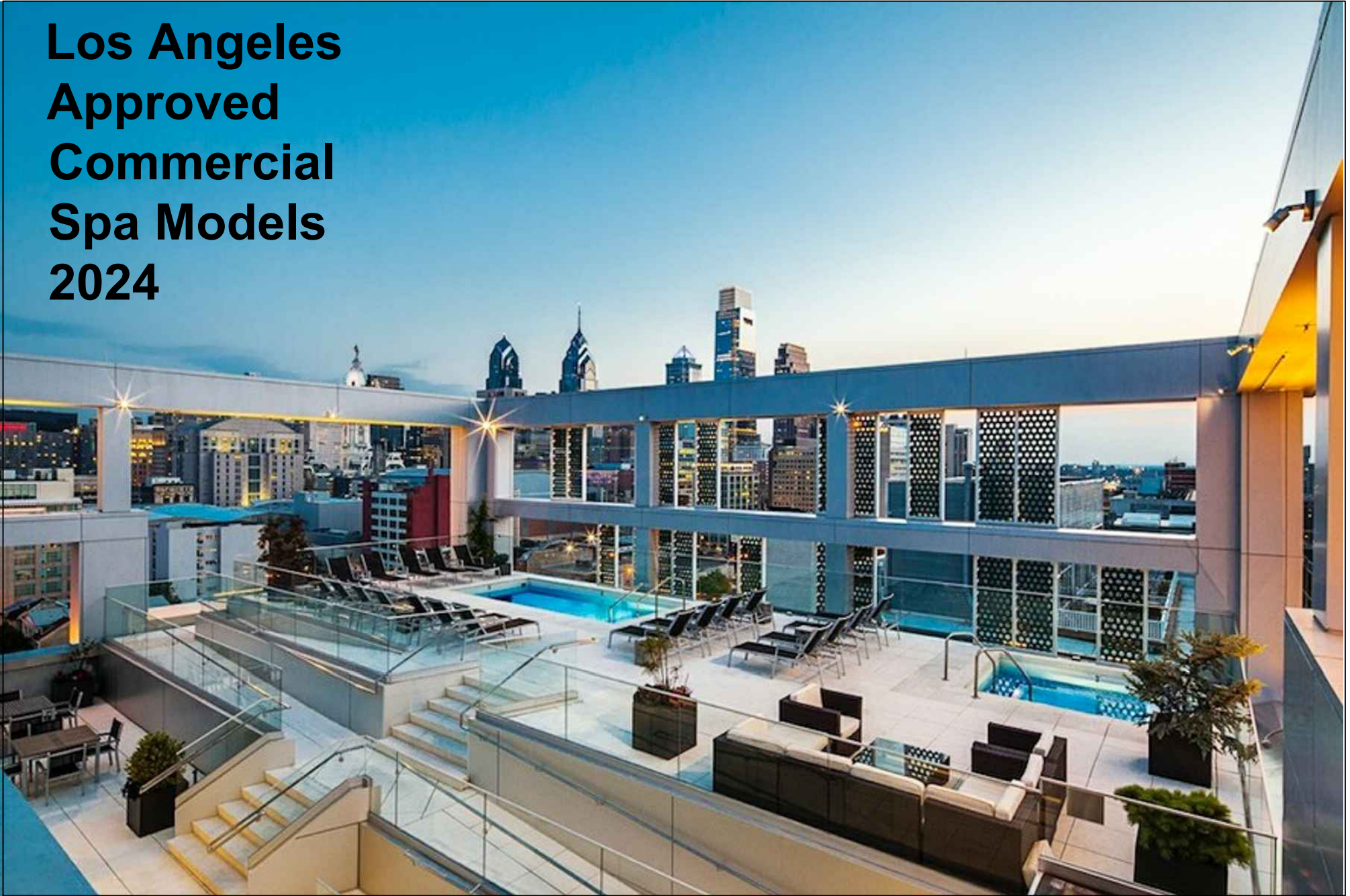

## INTRODUCTION

Public pools, including swimming pools, spas, spray grounds, wading pools, and special purpose pools located at apartments, condominiums, gated communities, hotels and motels, public and private schools, health clubs, city and county parks, mobile home parks, resorts and organizations, medical facilities, and water theme parks, are under the responsibility of the Los Angeles County Recreational Waters Program for plan review and approval. Public pools do not include individual therapeutic tubs or baths for cleaning the body, or pools at private single-family homes or dwellings with three units or fewer. This document contains requirements for submitting plans for a public pool in Los Angeles County. It also contains basic requirements of the California pool code.

### **Why are plans required?**

It is important for public health and safety that pools are constructed properly. Plan reviews and approvals are a cost-effective way to ensure that public pools meet the applicable code requirements and are safe. The California Health and Safety Code, the California Code of Regulations Title 22, and the California Building Code Title 24, provide the legal authority and requirements for the safe operation and construction of public pools.

### **When will the plans be reviewed?**

It is the goal of the Recreational Waters program to provide effective and efficient service in public health protection to all our clients. It is our goal to provide initial plan reviews within 20 days of plan submissions. Resubmissions with corrections take priority over new submissions and it is our goal to review them within 14 days.

### **Where can I get information?**

The Recreational Waters website has information, forms, and the fee schedule.  
<http://www.publichealth.lacounty.gov/eh/inspection/pool-plan-check.htm>  
You may also call our main office at (626) 430-5360.

### **Where can plans be submitted?**

Plans are submitted to the Recreational Waters Program at the Environmental Health Headquarter.

Los Angeles County Department of Public Health  
Environmental Health, Recreational Waters Program  
5050 Commerce Dr.  
Baldwin Park, CA 91706  
(626) 430-5360

# Recreational Waters Plan Check Flow Chart

Pool Plans Submitted to:  
Los Angeles County Department of Public Health  
Environmental Health Recreational Waters Program  
5050 Commerce Dr.  
Baldwin Park, CA 91706  
(626) 430-5360

Application and fees will be verified.  
Plans may not be accepted if the  
application is incomplete, or critical  
issues can be assessed at the counter.

Corrections made and  
plans resubmitted.  
Additional fees may be incurred for  
changes made beyond the scope  
of corrections

Plans Reviewed  
and Report Issued



Obtain Building Permits and Commence Construction  
Call at least 5 days before each of the following field inspections  
to make an appointment. Plan approval is valid for 2 years.

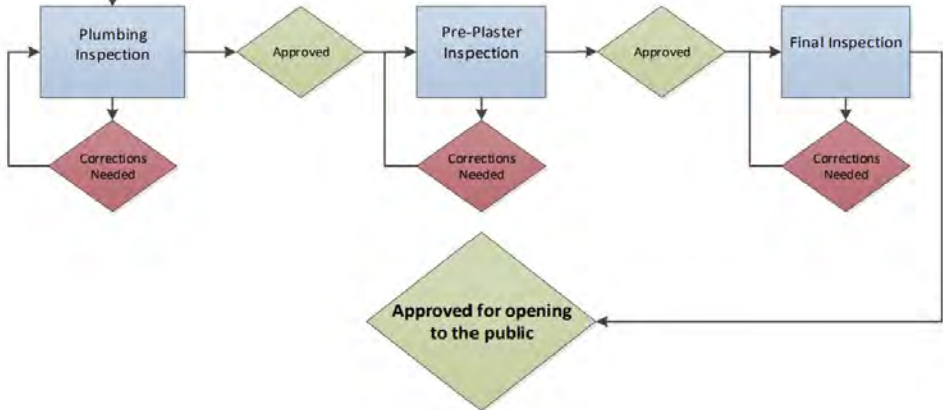

# SPA PLAN INDEX

**>Click< on SPA names  
to see plans**

**Go to DETAILS page>  
Go to WEB page>**

7.5' Acapulco (7'6"x7'6")  
Acapulco (7'x7')  
Acapulco II (7'x7')  
Acapulco III (7'6"x7'6")  
Acapulco IV (7'x7'1")  
Blackthorne (7'7"x8'9")  
Caribbean (8'x8')  
Corsica (6'x7'6")  
Corsica Modified (6'x9'6")  
Corsica 215 (7'x5'5")  
Corsica 215 C (Cold Plunge 7'x5'5")  
Eight Ft. Round  
Imperia (6'6"x7'10")  
Imperia II (7'6"x9'6")  
Jensen Deluxe (8'x8')  
Kidney (7'6"x11'2")  
Legacy 10 (7'6"x10')  
Legacy 12 (7'6"x12')  
Legacy 14 (7'6"x14')  
Legacy 16 (7'6"x16')  
Legacy 18 (7'6"x18')  
Legacy 20 (7'6"x20')  
Legacy 45 (10'3"x16' 7 1/2")  
Legacy CS (6'4"x10'4")  
Legacy CS (7'6"x16')  
Legacy CS (7'4"x18')  
Legacy CS (8'x12')  
Legacy CS (8'x15')  
Legacy CS 46 (8'x10')

Legacy DS (8'x20')  
Legacy DS (10'x20')  
Legacy DSA (8'x12')  
Legacy DSA (8'x14')  
Legacy DSA (8'x16')  
Legacy DSA (8'x18')  
Legacy DSA (8'x20')  
Legacy M (8'x20')  
Legacy Para (13'x15'6")  
Mirage 9 (7'6"x9')  
Mirage 11 (7'6"x11')  
Mirage 13 (7'6"x13')  
Mirage 15 (7'6"x15')  
Mirage 17 (7'6"x17')  
Maxima (6'7 5/8"x6' 7 5/8")  
Redwood (6'8"x20')  
Rimini (6'9"x7'6")  
Rimini Comm (8'6"x8'6")  
Round 7  
Round 9  
Round 11  
Serenity (7'x12')  
Six Ft. Round  
Swim Spa 12 (7'6"x12')  
Swim Spa 16 (7'6"x16')  
Swim Spa 18 (7'6"x18')  
Swim Spa 20 (7'6"x20')  
Tahoe (7'6"x9'2")  
Ten Ft. Round



## POOL PLAN INDEX

**>Click< on POOL names  
to see plans**

**Go to DETAILS page>  
Go to WEB page>**

**Legacy CS (12' x 18')**

**Legacy SQC (12' x 32')**

**Legacy (12' x 22')**

**Legacy (12'-11" x 19')**

**Modera 1327 (12' x 27'-6")**





## NESPA TILED SPAS

# APPROVED MODELS for Los Angeles County

---











2800 Richter Ave. Suite C, Oroville, CA 95965 • **voice:** (530)534-9910  
**email:** [jim@tiledspas.com](mailto:jim@tiledspas.com) • **website:** [www.tiledspas.com](http://www.tiledspas.com)

# 7.5' Acapulco

## MDL# 104-LA

SPECIFICATIONS	
SHELL WEIGHT:	2200 LBS.
WATER WEIGHT:	7503 LBS.
TOTAL SHELL & WATER WEIGHT:	9703.3 LBS.
WATER VOLUME:	120 Cu.Ft.
WATER GALLONS:	900 GAL.
SURFACE AREA:	56.3 SQ. FT.
SPA LENGTH:	7'-6"
SPA WIDTH:	7'-6"
SPA DEPTH	3'- 4"
PEOPLE	5
ICC ES LISTING #	PMG-1161
USPC LISTING #	SP14385

### LEGEND:

	SKIMMER	1
	MAIN DRAIN	2
	EQUALIZER	2
	B SUCTION	2
	JET	8
	RETURN	3
	WATER FILL	1
	STILLING	-
	VAC	-
	LIGHT	1
WATERPROOF SKID SUPPORT STRUCTURE ATTACHED TO SPA AT NESPA FACTORY  *SKIDS SUPPLIED BY NESPA		

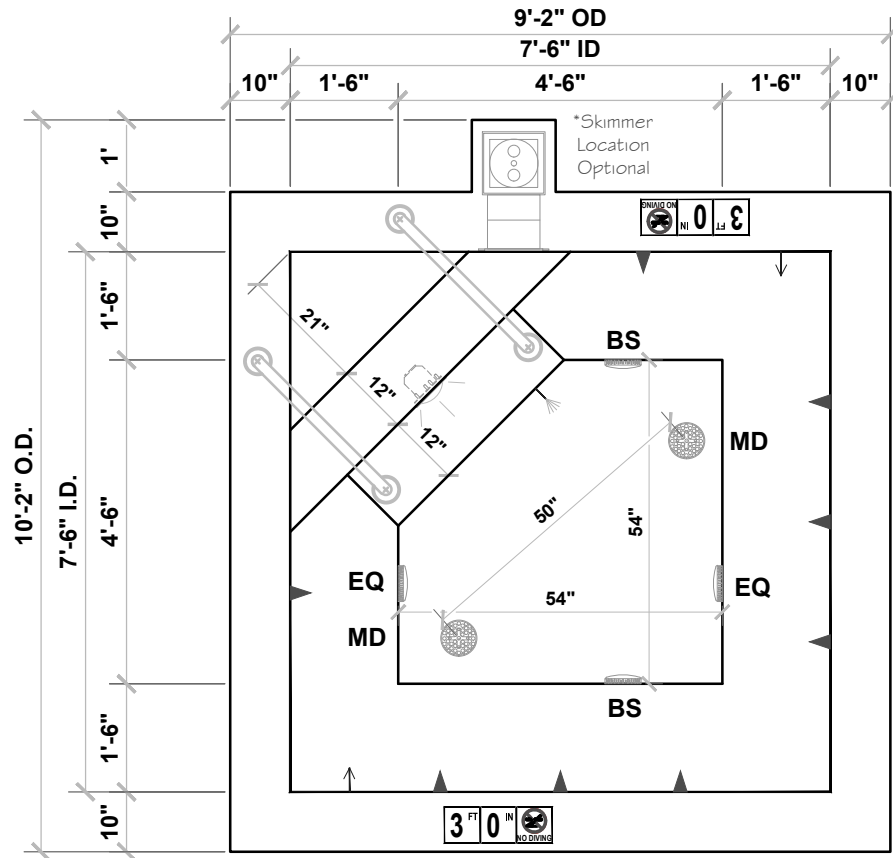

Approved for Commercial use  
Complies with VGB Pool  
& Spa Safety Act

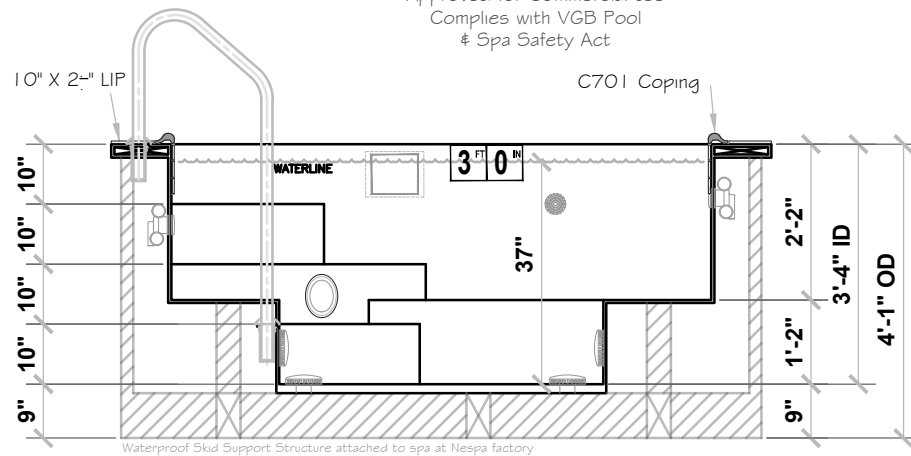











# Acapulco

## MDL# 103-LA

SPECIFICATIONS	
SHELL WEIGHT:	2000 LBS.
WATER WEIGHT:	6515 LBS.
TOTAL SHELL & WATER WEIGHT:	8515.4 LBS.
WATER VOLUME:	104.2 Cu.Ft.
WATER GALLONS:	782 GAL.
SURFACE AREA:	49.0 SQ. FT.
SPA LENGTH:	7'-0"
SPA WIDTH:	7'-0"
SPA DEPTH:	3'-4"
PEOPLE	4
ICC ES LISTING #	PMG-1161
USPC LISTING #	SP14385

### LEGEND:

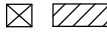
	SKIMMER	1
	MAIN DRAIN	2
	EQUALIZER	2
	B SUCTION	2
	JET	8
	RETURN	3
	WATER FILL	1
	STILLING	-
	VAC	-
	LIGHT	1
WATERPROOF SKID SUPPORT STRUCTURE ATTACHED TO SPA AT NESPA FACTORY  *SKIDS SUPPLIED BY NESPA		

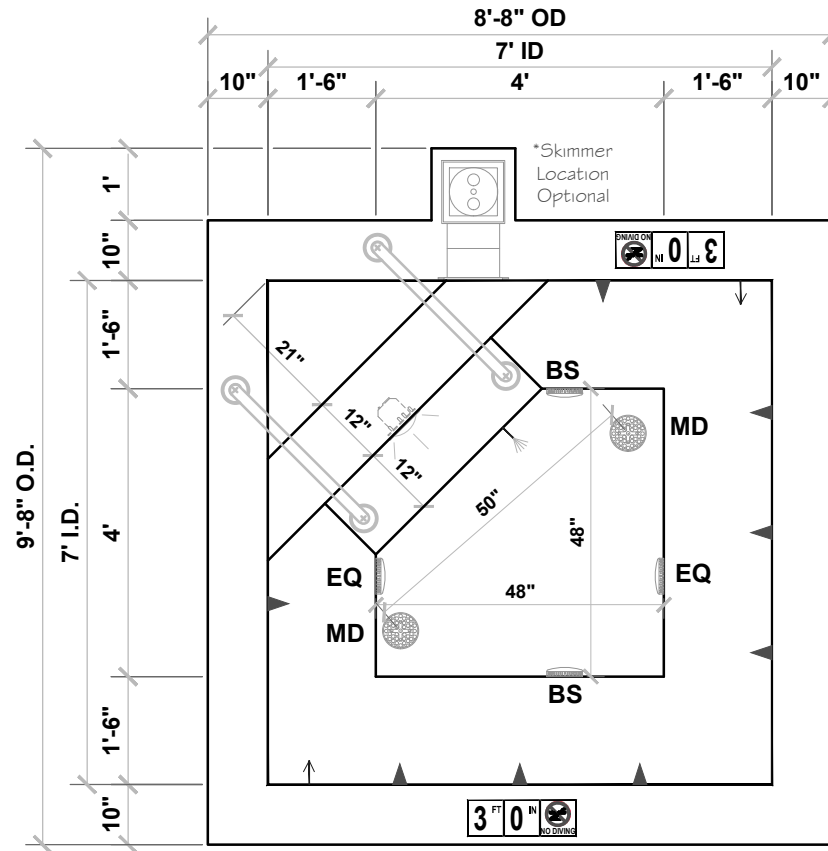

Approved for Commercial use  
Complies with VGB Pool  
# Spa Safety Act

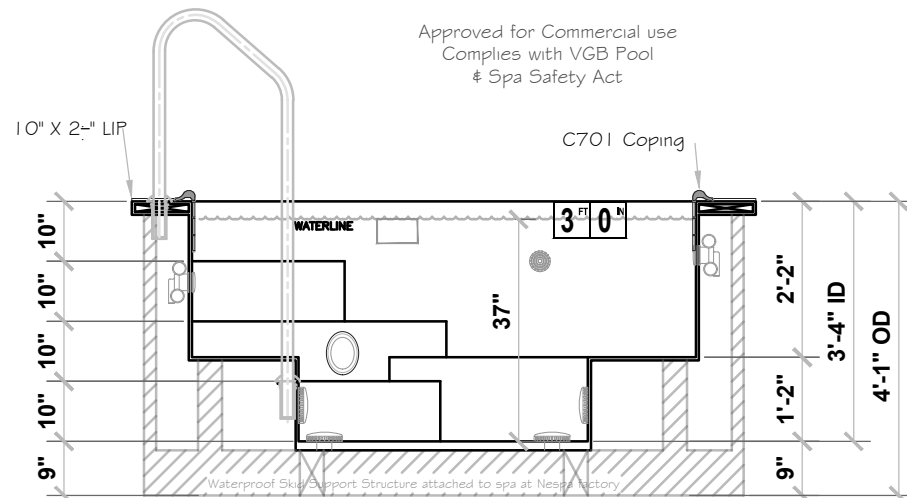













# Acapulco II

## MDL# 107-LA

SPECIFICATIONS	
SHELL WEIGHT:	2000 LBS.
WATER WEIGHT:	6565 LBS.
TOTAL SHELL & WATER WEIGHT:	8565.4 LBS.
WATER VOLUME:	105 Cu.Ft.
WATER GALLONS:	788 GAL.
SURFACE AREA:	49.0 SQ. FT.
SPA LENGTH:	7'-0"
SPA WIDTH:	7'-0"
SPA DEPTH	3'-4"
PEOPLE	4
ICC ES LISTING #	PMG-1161
USPC LISTING #	SP14385

### LEGEND:

	SKIMMER	1
	MAIN DRAIN	2
	EQUALIZER	2
	B SUCTION	2
	JET	8
	RETURN	3
	WATER FILL	1
	STILLING	-
	VAC	-
	LIGHT	1
WATERPROOF SKID SUPPORT STRUCTURE ATTACHED TO SPA AT NESPA FACTORY  *SKIDS SUPPLIED BY NESPA		

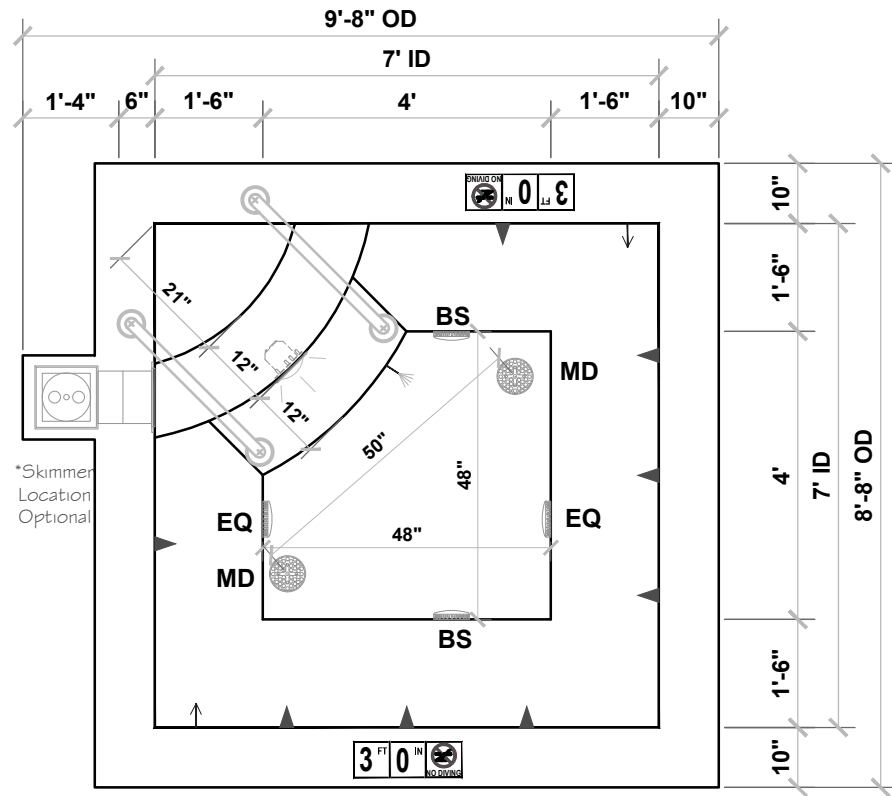

Approved for Commercial use  
Complies with VGB Pool  
‡ Spa Safety Act

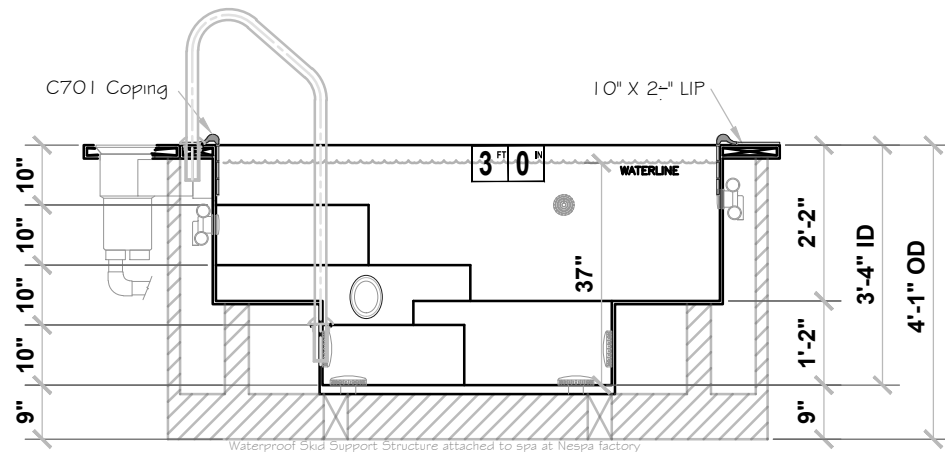











# Acapulco III

## MDL# 108-LA

SPECIFICATIONS	
SHELL WEIGHT:	2200 LBS.
WATER WEIGHT:	7566 LBS.
TOTAL SHELL & WATER WEIGHT:	9765.8 LBS.
WATER VOLUME:	121 Cu.Ft.
WATER GALLONS:	908 GAL.
SURFACE AREA:	56.3 SQ. FT.
SPA LENGTH:	7'-6"
SPA WIDTH:	7'-6"
SPA DEPTH	3'-4"
PEOPLE	5
ICC ES LISTING #	PMG-1161
USPC LISTING #	SP14385

### LEGEND:

	SKIMMER	1
	MAIN DRAIN	2
	EQUALIZER	2
	B SUCTION	4
	JET	10
	RETURN	3
	WATER FILL	1
	STILLING	-
	VAC	-
	LIGHT	1
WATERPROOF SKID SUPPORT STRUCTURE ATTACHED TO SPA AT NESPA FACTORY  *SKIDS SUPPLIED BY NESPA		

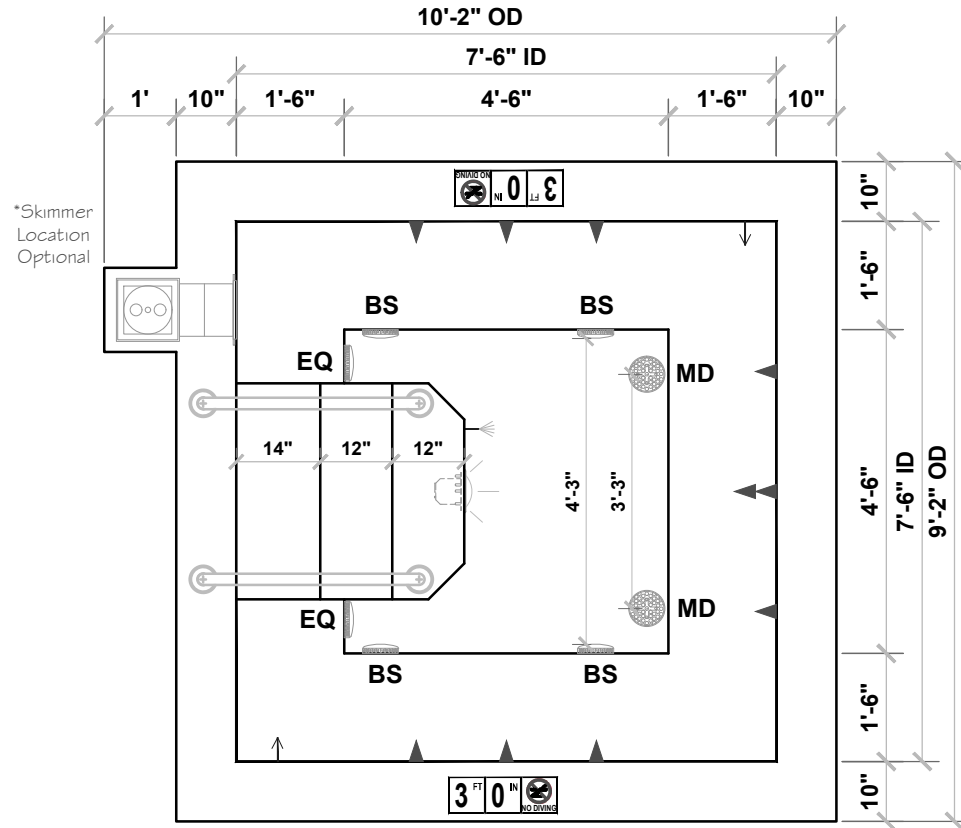

Approved for Commercial use  
Complies with VGB Pool  
# Spa Safety Act

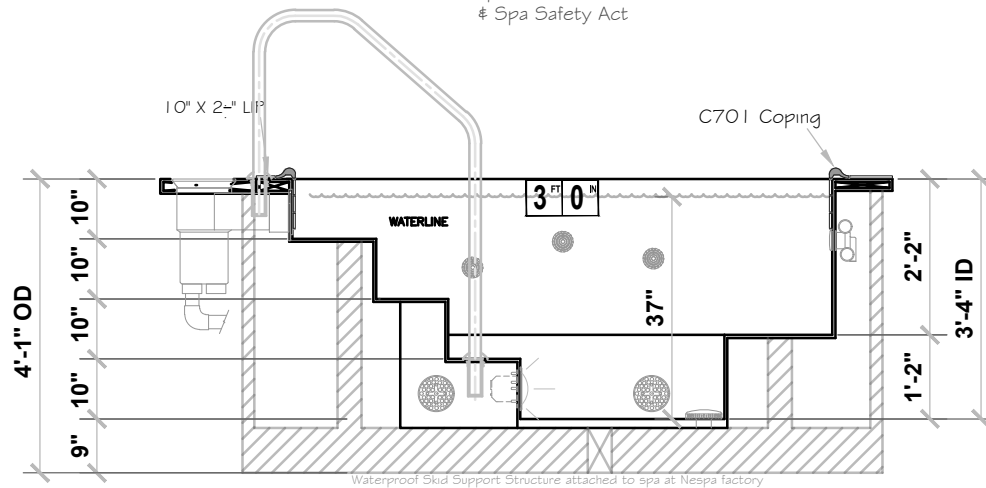











# Acapulco IV

## MDL# 109-LA

SPECIFICATIONS	
SHELL WEIGHT:	2750 LBS.
WATER WEIGHT:	11255 LBS.
TOTAL SHELL & WATER WEIGHT:	14005 LBS.
WATER VOLUME:	180 Cu.Ft.
WATER GALLONS:	1350 GAL.
SURFACE AREA:	56.3 SQ. FT.
SPA LENGTH:	9'-0"
SPA WIDTH:	9'-0"
SPA DEPTH	3'-4"
PEOPLE	7
ICC ES LISTING #	PMG-1161
USPC LISTING #	SP14385

### LEGEND:

	SKIMMER	1
	MAIN DRAIN	2
	EQUALIZER	2
	B SUCTION	4
	JET	10
	RETURN	3
	WATER FILL	1
	STILLING	-
	VAC	-
	LIGHT	1
<b>WATERPROOF SKID SUPPORT STRUCTURE ATTACHED TO SPA AT NESPA FACTORY</b>  *SKIDS SUPPLIED BY NESPA		

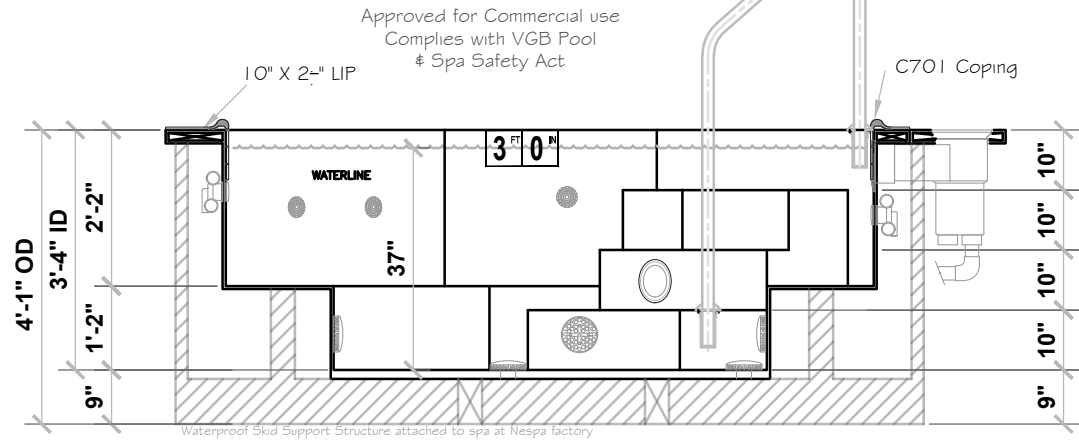
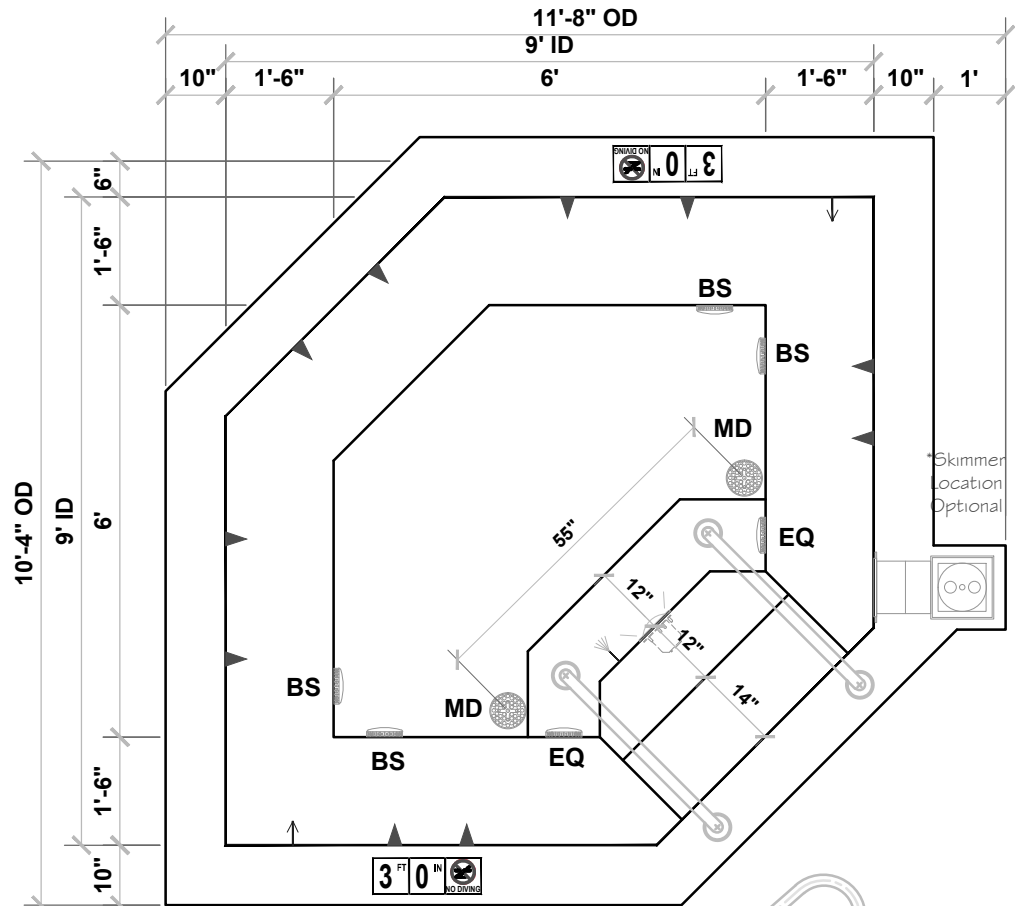

# Blackthorn

## MDL# 305-LA

SPECIFICATIONS	
SHELL WEIGHT:	2300 LBS.
WATER WEIGHT:	6628 LBS.
TOTAL SHELL & WATER WEIGHT:	8927.9 LBS.
WATER VOLUME:	106 Cu.Ft.
WATER GALLONS:	795 GAL.
SURFACE AREA:	50.6 SQ. FT.
SPA LENGTH:	8'-9"
SPA WIDTH:	7'-7"
SPA DEPTH:	3'-4"
PEOPLE	5
ICC ES LISTING #	PMG-1161
USPC LISTING #	SP14385

### LEGEND:

	SKIMMER	1
	MAIN DRAIN	2
	EQUALIZER	2
	B SUCTION	2
	JET	9
	RETURN	3
	WATER FILL	1
	STILLING	-
	VAC	-
	LIGHT	1
WATERPROOF SKID SUPPORT STRUCTURE ATTACHED TO SPA AT NESPA FACTORY *SKIDS SUPPLIED BY NESPA		

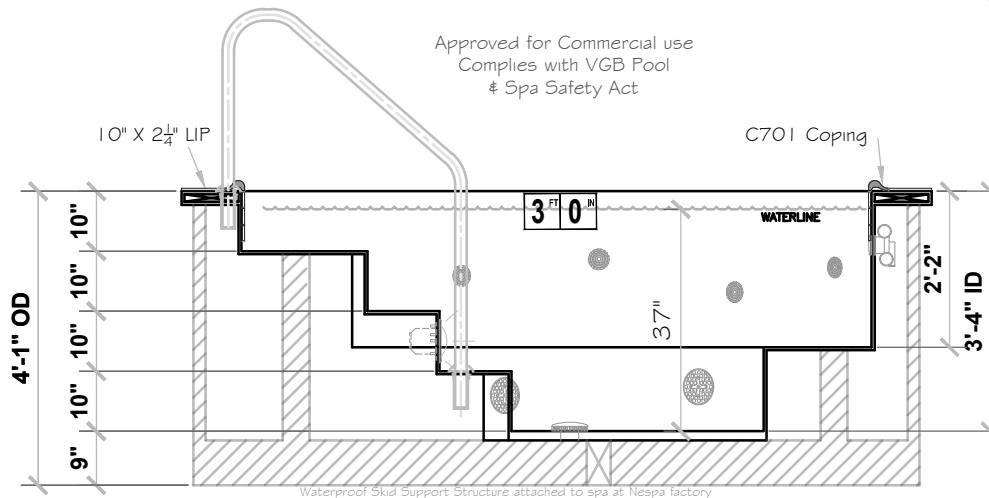
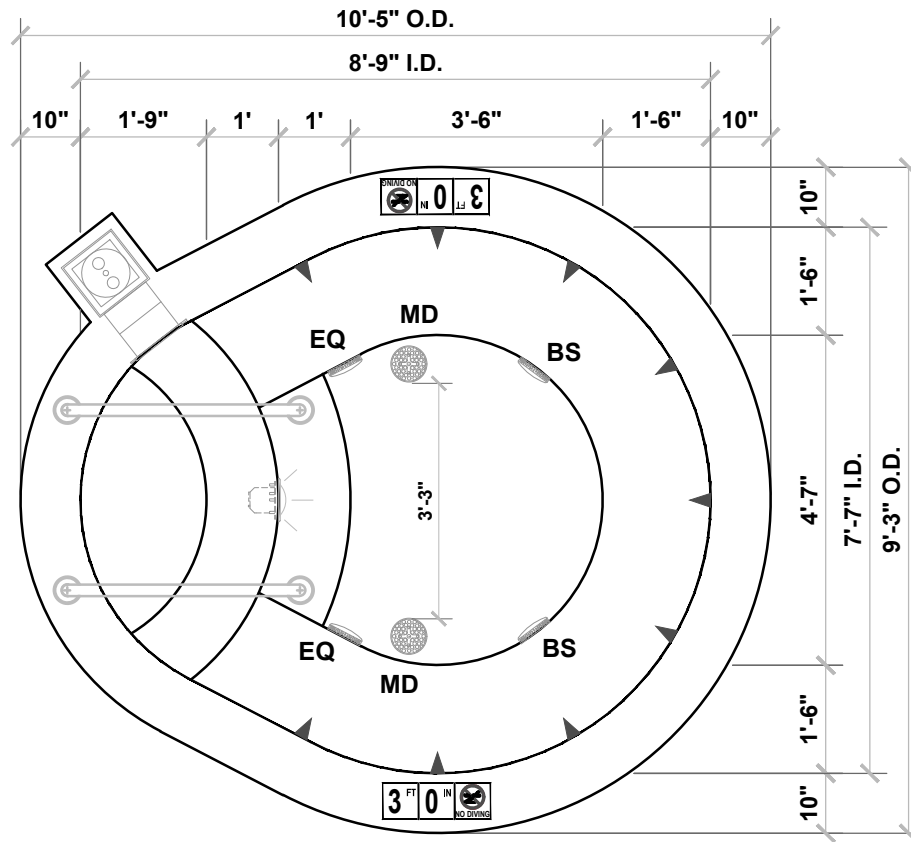

Approved for Commercial use  
Complies with VGB Pool  
& Spa Safety Act















# Caribbean

## MDL# 111-LA

SPECIFICATIONS	
SHELL WEIGHT:	2500 LBS.
WATER WEIGHT:	9004 LBS.
TOTAL SHELL & WATER WEIGHT:	11504 LBS.
WATER VOLUME:	144 Cu.Ft.
WATER GALLONS:	1080 GAL.
SURFACE AREA:	64.0 SQ. FT.
SPA LENGTH:	8'-0"
SPA WIDTH:	8'-0"
SPA DEPTH	3'-4"
PEOPLE	6
ICC ES LISTING #	PMG-1161
USPC LISTING #	SP14385

### LEGEND:

	SKIMMER	1
	MAIN DRAIN	2
	EQUALIZER	2
	B SUCTION	2
	JET	8
	RETURN	3
	WATER FILL	1
	STILLING	-
	VAC	-
	LIGHT	1
WATERPROOF SKID SUPPORT STRUCTURE ATTACHED TO SPA AT NESPA FACTORY   *SKIDS SUPPLIED BY NESPA		

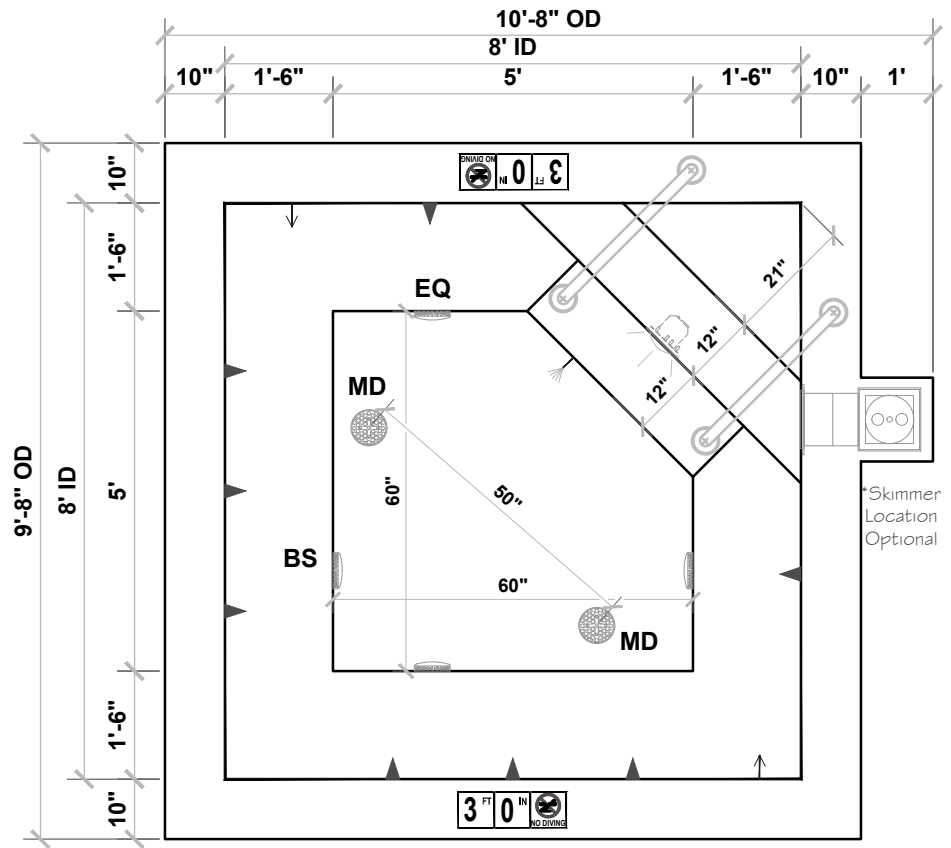



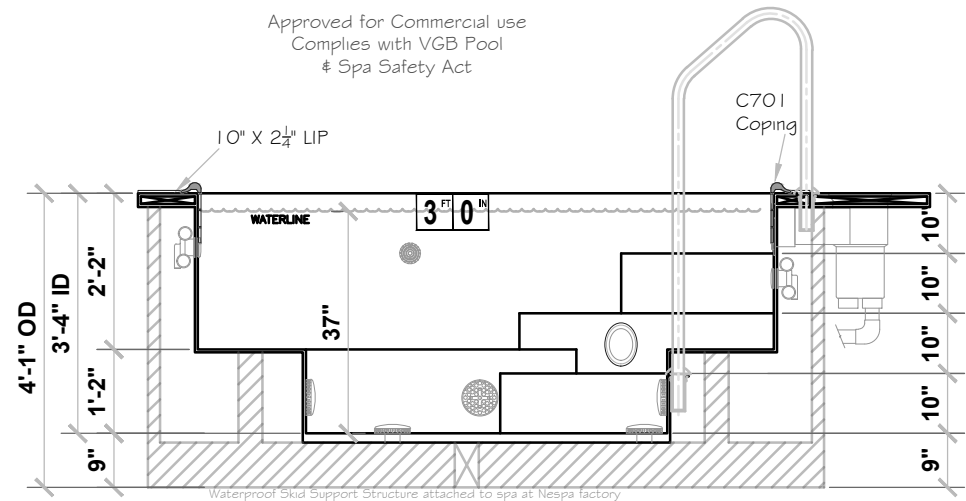







Approved for Commercial use  
Complies with VGB Pool  
& Spa Safety Act



# Corsica MDL# 203-LA

SPECIFICATIONS	
SHELL WEIGHT:	1900 LBS.
WATER WEIGHT:	5690 LBS.
TOTAL SHELL & WATER WEIGHT:	7590 LBS.
WATER VOLUME:	91 Cu.Ft.
WATER GALLONS:	683 GAL.
SURFACE AREA:	45.0 SQ. FT.
SPA LENGTH:	7'-6"
SPA WIDTH:	6'-0"
SPA DEPTH	3'-2"
PEOPLE	4
ICC ES LISTING #	PMG-1161
USPC LISTING #	SP14385

## LEGEND:



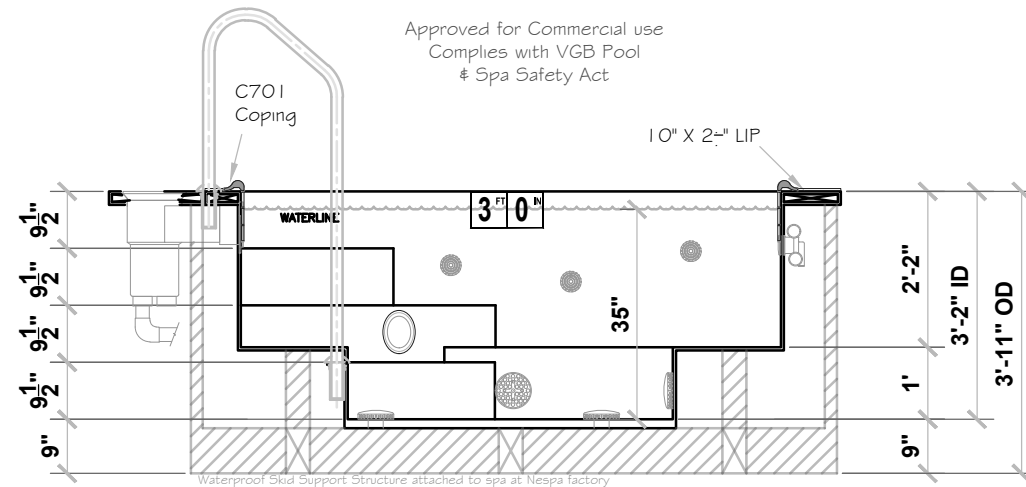
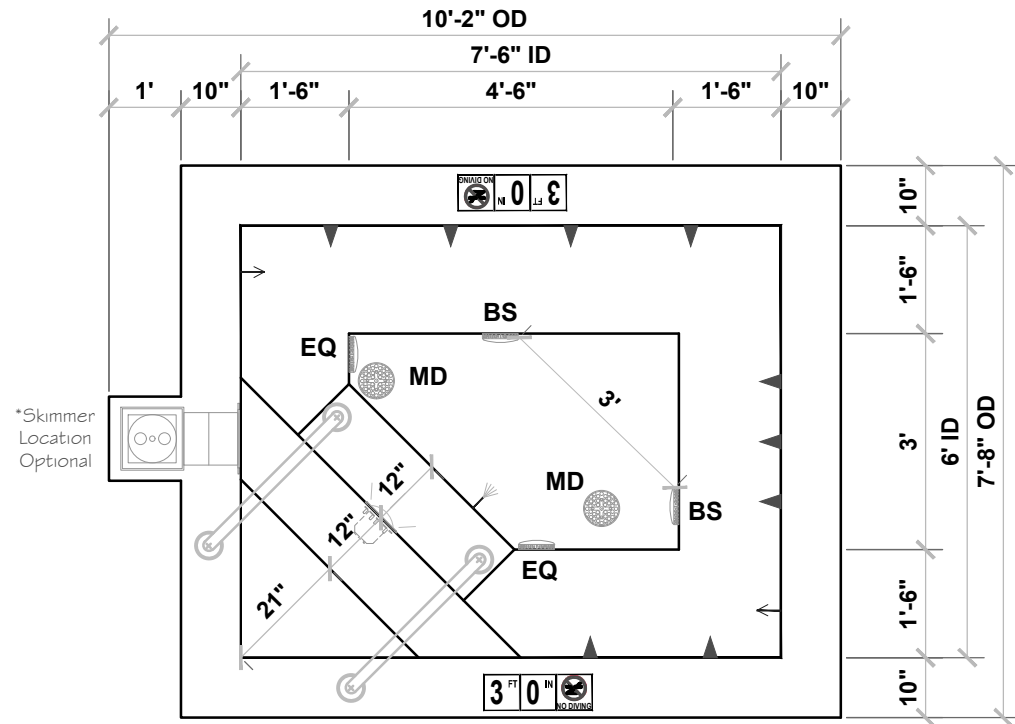









	SKIMMER	1
	MAIN DRAIN	2
	EQUALIZER	2
	B SUCTION	2
	JET	9
	RETURN	3
	WATER FILL	1
	STILLING	-
	VAC	-
	LIGHT	1
<b>WATERPROOF SKID SUPPORT STRUCTURE ATTACHED TO SPA AT NESPA FACTORY</b>  *SKIDS SUPPLIED BY NESPA		



# Corsica Mod. MDL# 206-LA

SPECIFICATIONS	
SHELL WEIGHT:	1900 LBS.
WATER WEIGHT:	5690 LBS.
TOTAL SHELL & WATER WEIGHT:	7590 LBS.
WATER VOLUME:	91 Cu.Ft.
WATER GALLONS:	683 GAL.
SURFACE AREA:	57.0 SQ. FT.
SPA LENGTH:	9'-6"
SPA WIDTH:	6'-0"
SPA DEPTH	3'-2"
PEOPLE	5
ICC ES LISTING #	PMG-1161
USPC LISTING #	SP14385

## LEGEND:

	SKIMMER	1
	MAIN DRAIN	2
	EQUALIZER	2
	B SUCTION	2
	JET	10
	RETURN	3
	WATER FILL	1
	STILLING	-
	VAC	-
	LIGHT	1
WATERPROOF SKID SUPPORT STRUCTURE ATTACHED TO SPA AT NESPA FACTORY   *SKIDS SUPPLIED BY NESPA		

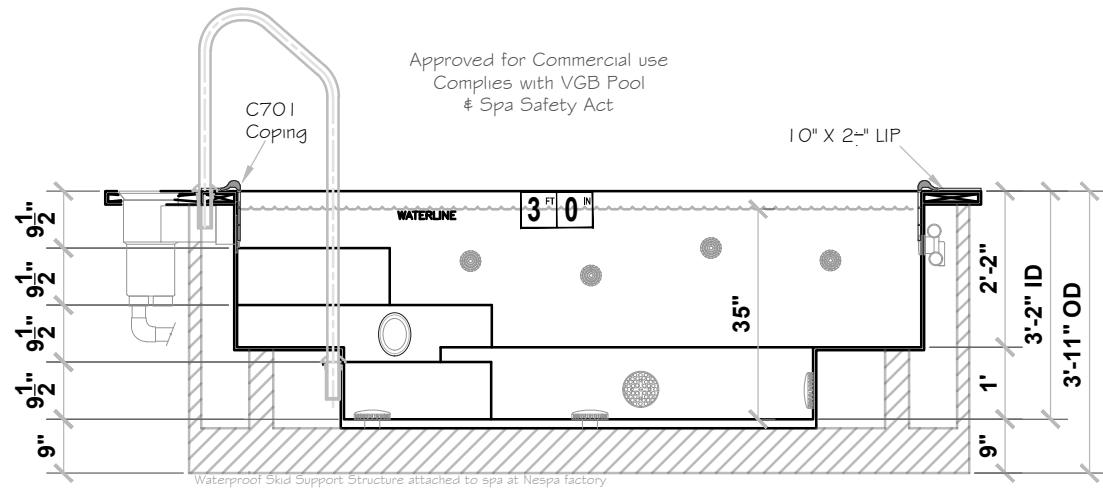
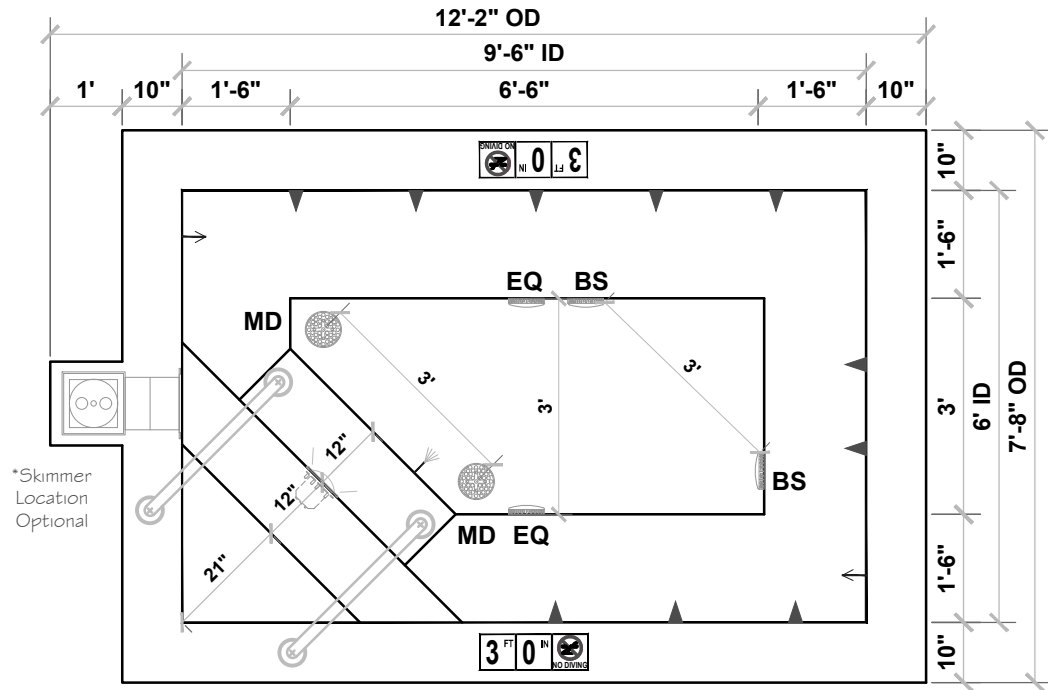













# 7 X 5.5 Corsica SPA

## MDL# 215

SPECIFICATIONS	
SHELL WEIGHT:	1900 LBS.
WATER WEIGHT:	5402 LBS.
TOTAL SHELL & WATER WEIGHT:	7302.4 LBS.
WATER VOLUME:	86.4 Cu.Ft.
WATER GALLONS:	648 GAL.
SURFACE AREA:	38.5 SQ. FT.
SPA LENGTH:	7'-0"
SPA WIDTH:	5'-6"
SPA DEPTH	3'-8"
PEOPLE	3
ICC ES LISTING #	PMG-1161
USPC LISTING #	SP14385

### LEGEND:

	SKIMMER	1
	MAIN DRAIN	2
	EQUALIZER	2
	B SUCTION	2
	JET	6
	RETURN	3
	WATER FILL	1
	STILLING	-
	VAC	-
	LIGHT	1
WATERPROOF SKID SUPPORT STRUCTURE ATTACHED TO SPA AT NESPA FACTORY   *SKIDS SUPPLIED BY NESPA		

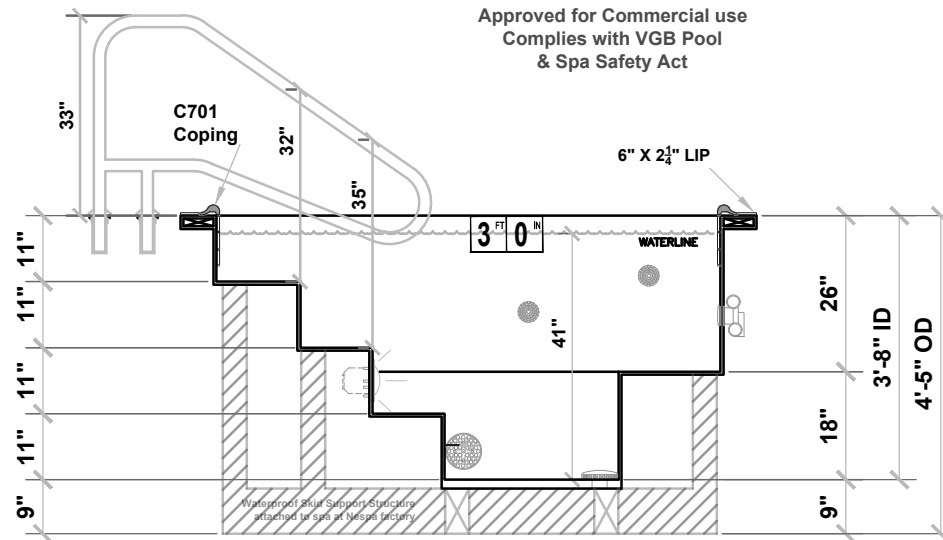
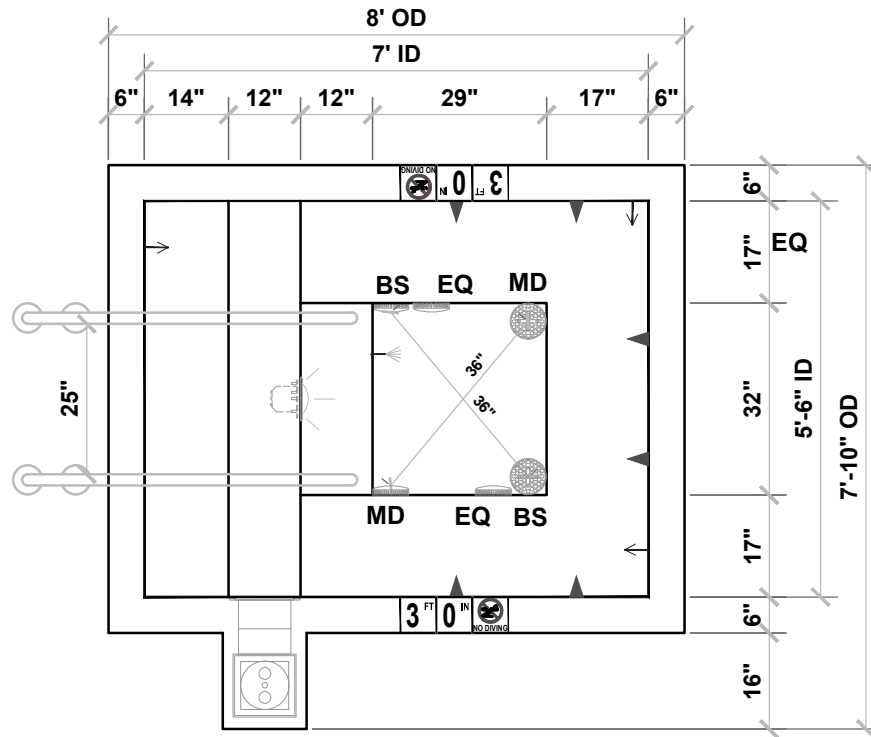















# 7 X 5.5 Corsica Cold Plunge MDL# 215C

SPECIFICATIONS	
SHELL WEIGHT:	1900 LBS.
WATER WEIGHT:	5402 LBS.
TOTAL SHELL & WATER WEIGHT:	7302.4 LBS.
WATER VOLUME:	86.4 Cu.Ft.
WATER GALLONS:	648 GAL.
SURFACE AREA:	38.5 SQ. FT.
SPA LENGTH:	7'-0"
SPA WIDTH:	5'-6"
SPA DEPTH	3'-8"
PEOPLE	3
ICC ES LISTING #	PMG-1161
USPC LISTING #	SP14385

## LEGEND:

	SKIMMER	1
	MAIN DRAIN	2
	EQUALIZER	2
	B SUCTION	-
	JET	-
	RETURN	3
	WATER FILL	1
	STILLING	-
	VAC	-
	LIGHT	1
WATERPROOF SKID SUPPORT STRUCTURE ATTACHED TO SPA AT NESPA FACTORY   *SKIDS SUPPLIED BY NESPA		

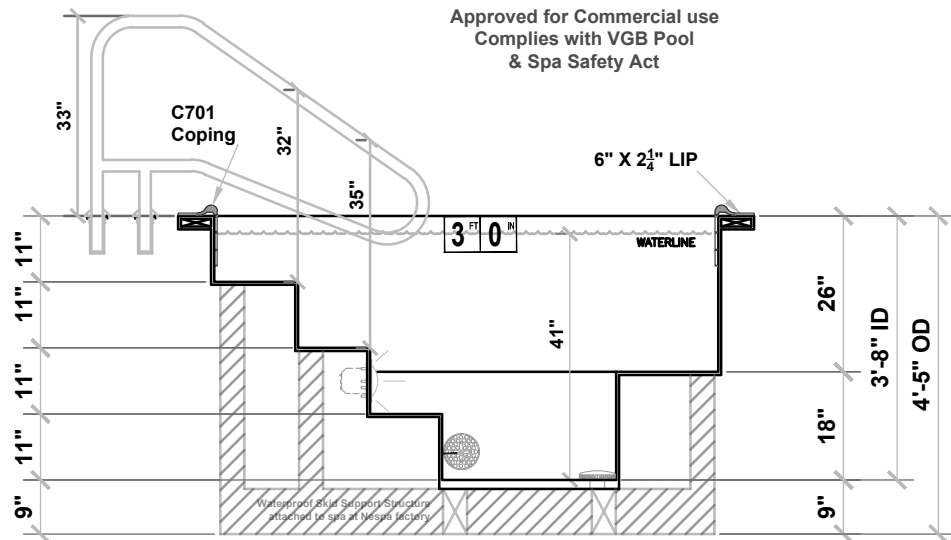
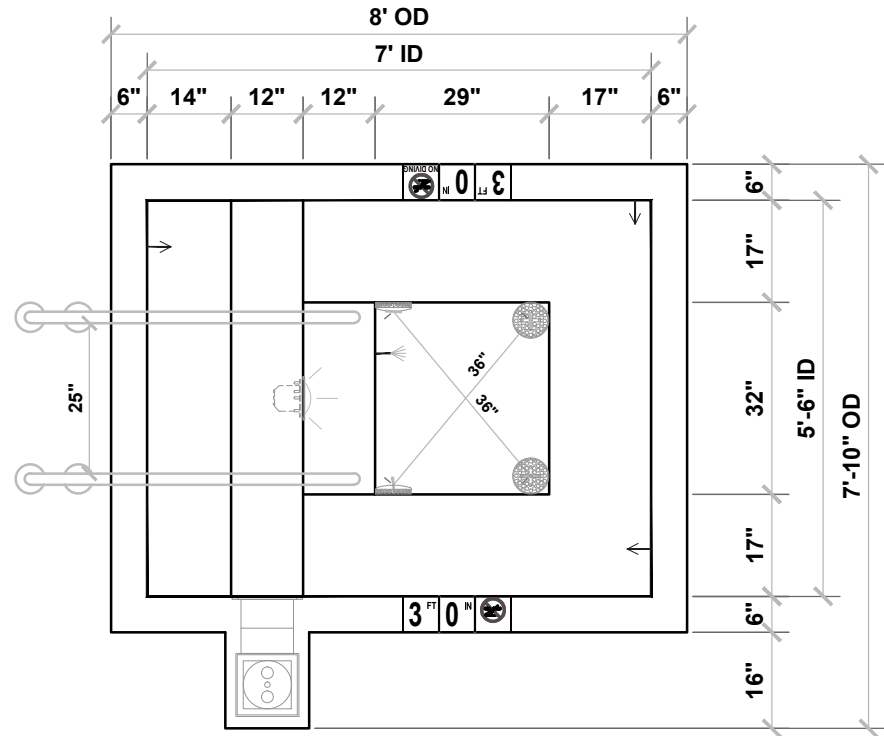











Approved for Commercial use  
Complies with VGB Pool  
& Spa Safety Act

# Imperia MDL# 201-LA

SPECIFICATIONS	
SHELL WEIGHT:	2100 LBS.
WATER WEIGHT:	7066 LBS.
TOTAL SHELL & WATER WEIGHT:	9165.6 LBS.
WATER VOLUME:	113 Cu.Ft.
WATER GALLONS:	848 GAL.
SURFACE AREA:	54.2 SQ. FT.
SPA LENGTH:	6'-6"
SPA WIDTH:	7'-10"
SPA DEPTH	3'-2"
PEOPLE	5
ICC ES LISTING #	PMG-1161
USPC LISTING #	SP14385

## LEGEND:

	SKIMMER	1
	MAIN DRAIN	2
	EQUALIZER	2
	B SUCTION	2
	JET	8
	RETURN	3
	WATER FILL	1
	STILLING	-
	VAC	-
	LIGHT	1

WATERPROOF SKID SUPPORT STRUCTURE ATTACHED TO SPA AT NESPA FACTORY

 \*SKIDS SUPPLIED BY NESPA

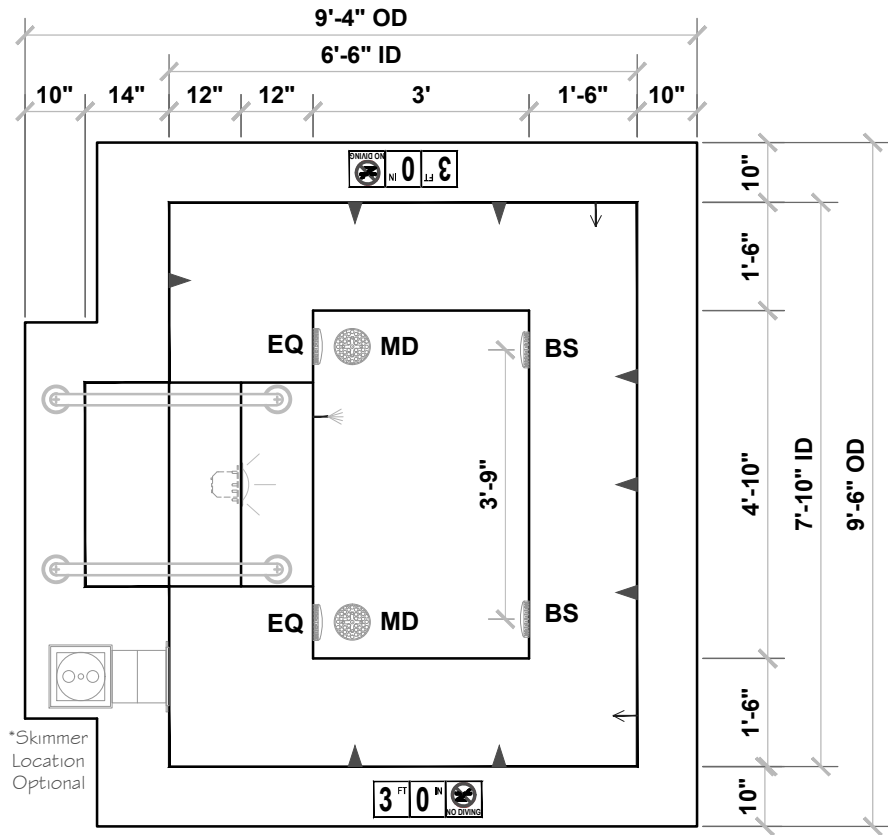

Approved for Commercial use  
Complies with VGB Pool  
& Spa Safety Act

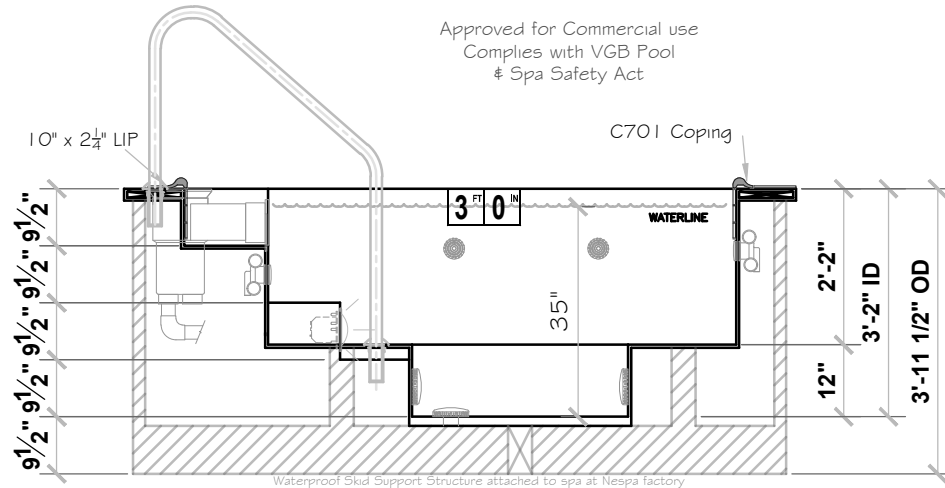

Waterproof Skid Support Structure attached to spa at Nespa factory



# Imperia II

## MDL# 202-LA

SPECIFICATIONS	
SHELL WEIGHT:	2500 LBS.
WATER WEIGHT:	10755 LBS.
TOTAL SHELL & WATER WEIGHT:	13254.7 LBS.
WATER VOLUME:	172 Cu.Ft.
WATER GALLONS:	1290 GAL.
SURFACE AREA:	74.8 SQ. FT.
SPA LENGTH:	9'-6"
SPA WIDTH:	7'-6"
SPA DEPTH:	3'-4"
PEOPLE:	7
ICC ES LISTING #	PMG-1161
USPC LISTING #	SP14385

### LEGEND:

	SKIMMER	1
	MAIN DRAIN	2
	EQUALIZER	2
	B SUCTION	4
	JET	11
	RETURN	3
	WATER FILL	1
	STILLING	-
	VAC	-
	LIGHT	1
WATERPROOF SKID SUPPORT STRUCTURE ATTACHED TO SPA AT NESPA FACTORY *SKIDS SUPPLIED BY NESPA		

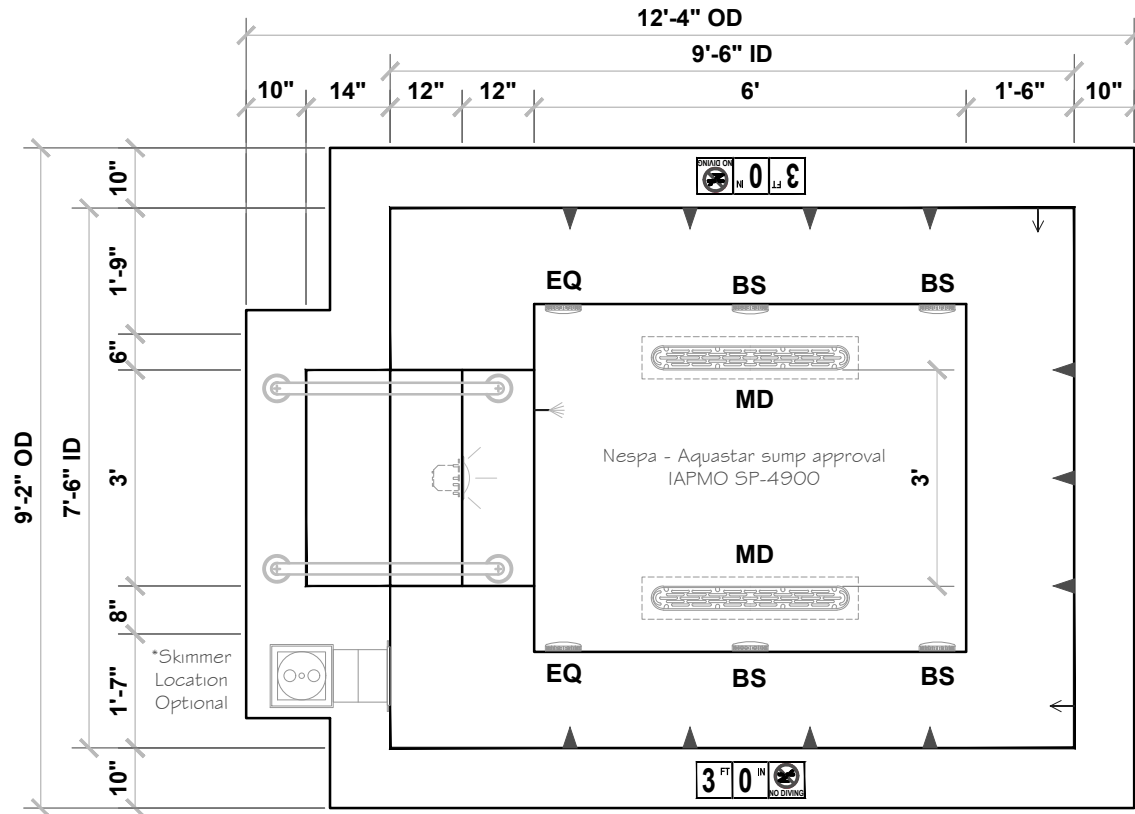

Approved for Commercial use  
Complies with VGB Pool  
& Spa Safety Act

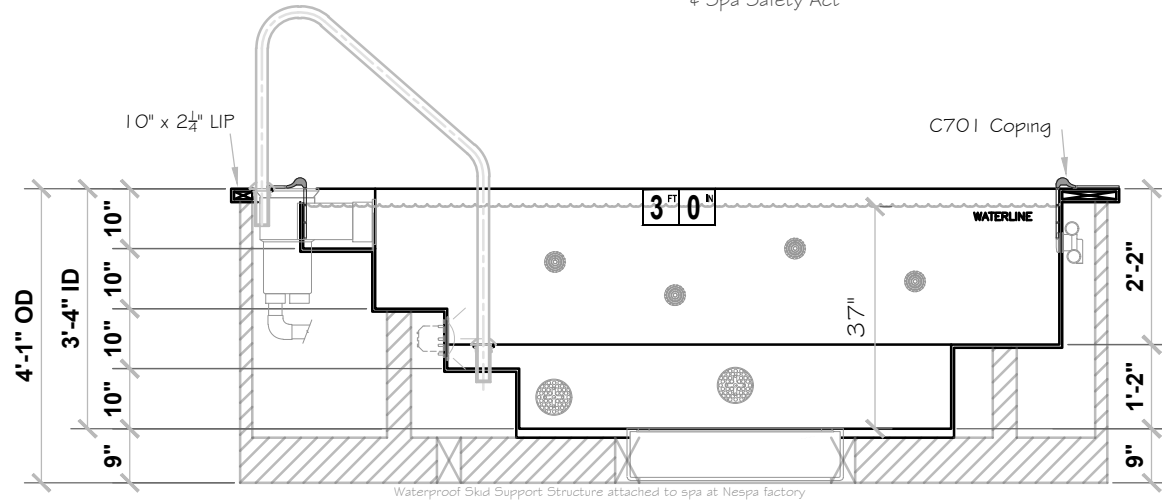











# JENSEN DELUXE

## MDL# 122-LA

SPECIFICATIONS	
SHELL WEIGHT:	2300 LBS.
WATER WEIGHT:	8191 LBS.
TOTAL SHELL & WATER WEIGHT:	10491.1 LBS.
WATER VOLUME:	131 Cu.Ft.
WATER GALLONS:	983 GAL.
SURFACE AREA:	64.0 SQ. FT.
SPA LENGTH:	8'-0"
SPA WIDTH:	8'-0"
SPA DEPTH:	3'-6"
PEOPLE	6
ICC ES LISTING #	PMG-1161
USPC LISTING #	SP14385

### LEGEND:

	SKIMMER	1
	MAIN DRAIN	2
	EQUALIZER	2
	B SUCTION	2
	JET	8
	RETURN	3
	WATER FILL	1
	STILLING	-
	VAC	-
	LIGHT	1
WATERPROOF SKID SUPPORT STRUCTURE ATTACHED TO SPA AT NESPA FACTORY  *SKIDS SUPPLIED BY NESPA		

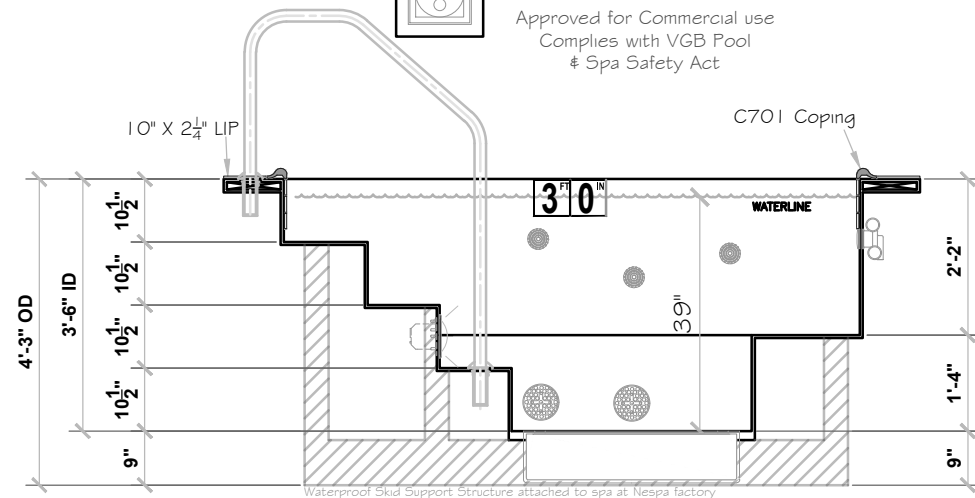
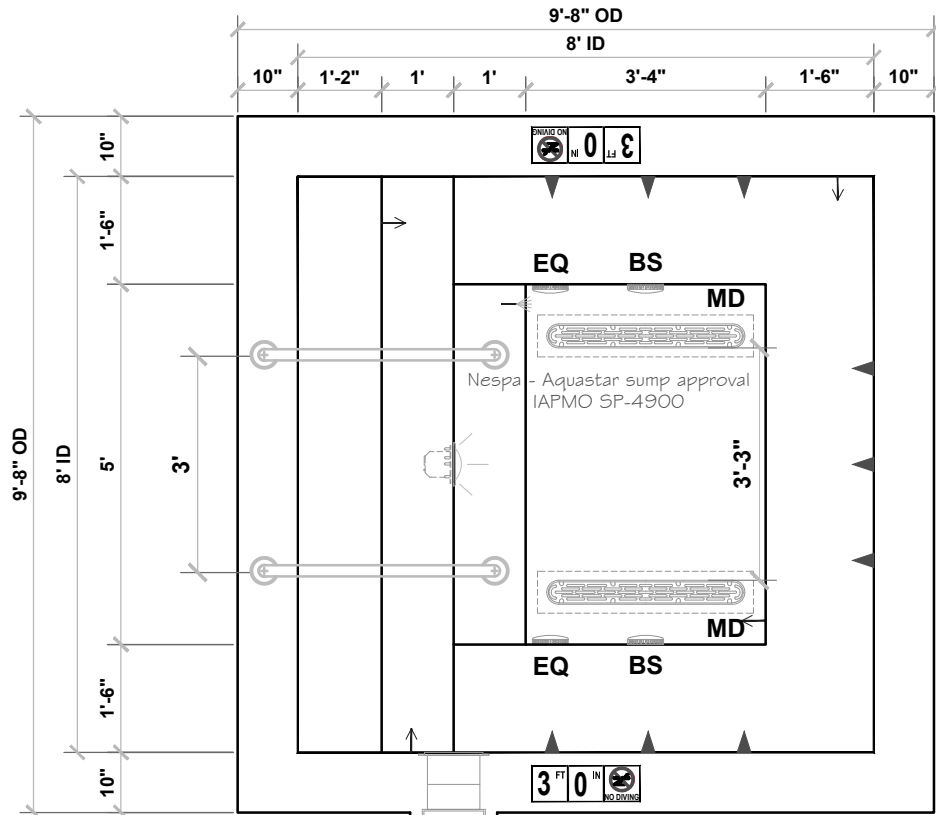











# 12' Kidney

## MDL# 304-LA

SPECIFICATIONS	
SHELL WEIGHT:	2700 LBS.
WATER WEIGHT:	9398 LBS.
TOTAL SHELL & WATER WEIGHT:	12097.9 LBS.
WATER VOLUME:	150.3 Cu.Ft.
WATER GALLONS:	1127 GAL.
SURFACE AREA:	67.9 SQ. FT.
SPA LENGTH:	11'-2"
SPA WIDTH:	7'-6"
SPA DEPTH	3'-6"
PEOPLE	6
ICC ES LISTING #	PMG-1161
USPC LISTING #	SP14385

### LEGEND:

	SKIMMER	1
	MAIN DRAIN	2
	EQUALIZER	2
	B SUCTION	4
	JET	12
	RETURN	3
	WATER FILL	1
	STILLING	-
	VAC	-
	LIGHT	1
WATERPROOF SKID SUPPORT STRUCTURE ATTACHED TO SPA AT NESPA FACTORY   *SKIDS SUPPLIED BY NESPA		

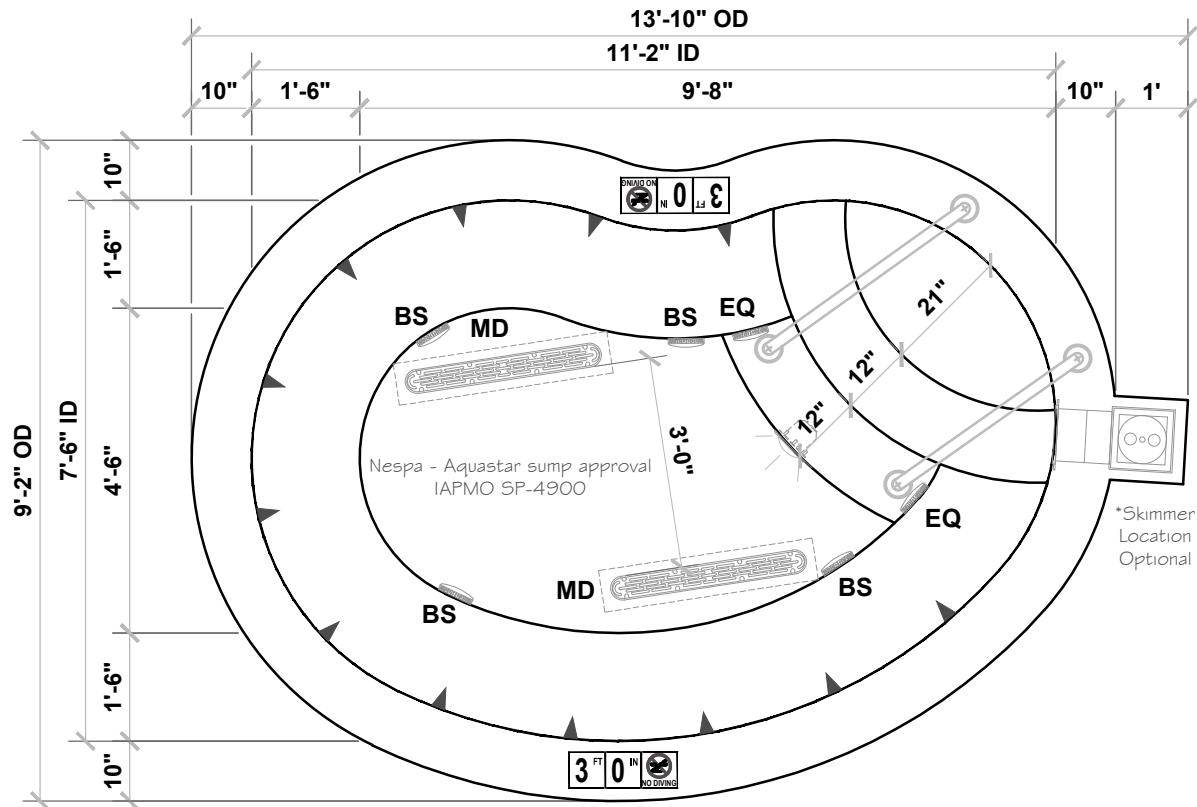

Approved for Commercial use  
Complies with VGB Pool  
& Spa Safety Act

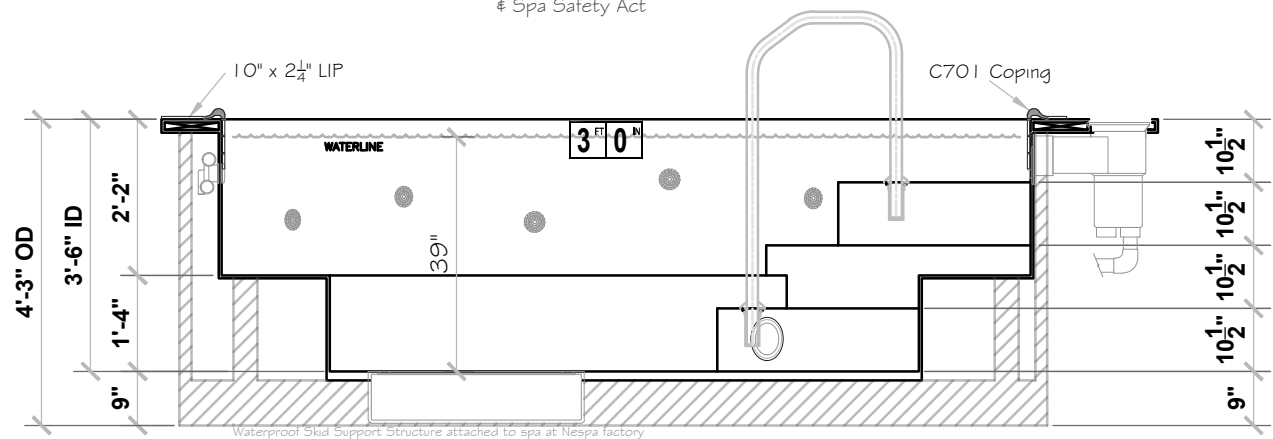













# 10' Legacy

## MDL# 701-LA

SPECIFICATIONS	
SHELL WEIGHT:	2600 LBS.
WATER WEIGHT:	10217 LBS.
TOTAL SHELL & WATER WEIGHT:	12817 LBS.
WATER VOLUME:	163.4 Cu.Ft.
WATER GALLONS:	1226 GAL.
SURFACE AREA:	75.0 SQ. FT.
SPA LENGTH:	10'-0"
SPA WIDTH:	7'-6"
SPA DEPTH	3'-6"
PEOPLE	7
ICC ES LISTING #	PMG-1161
USPC LISTING #	SP14385

### LEGEND:



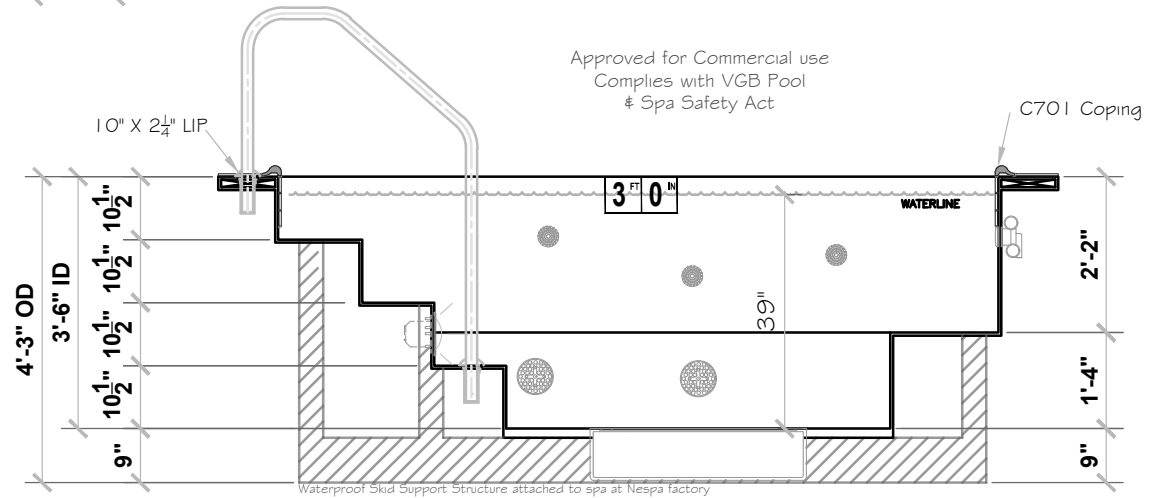
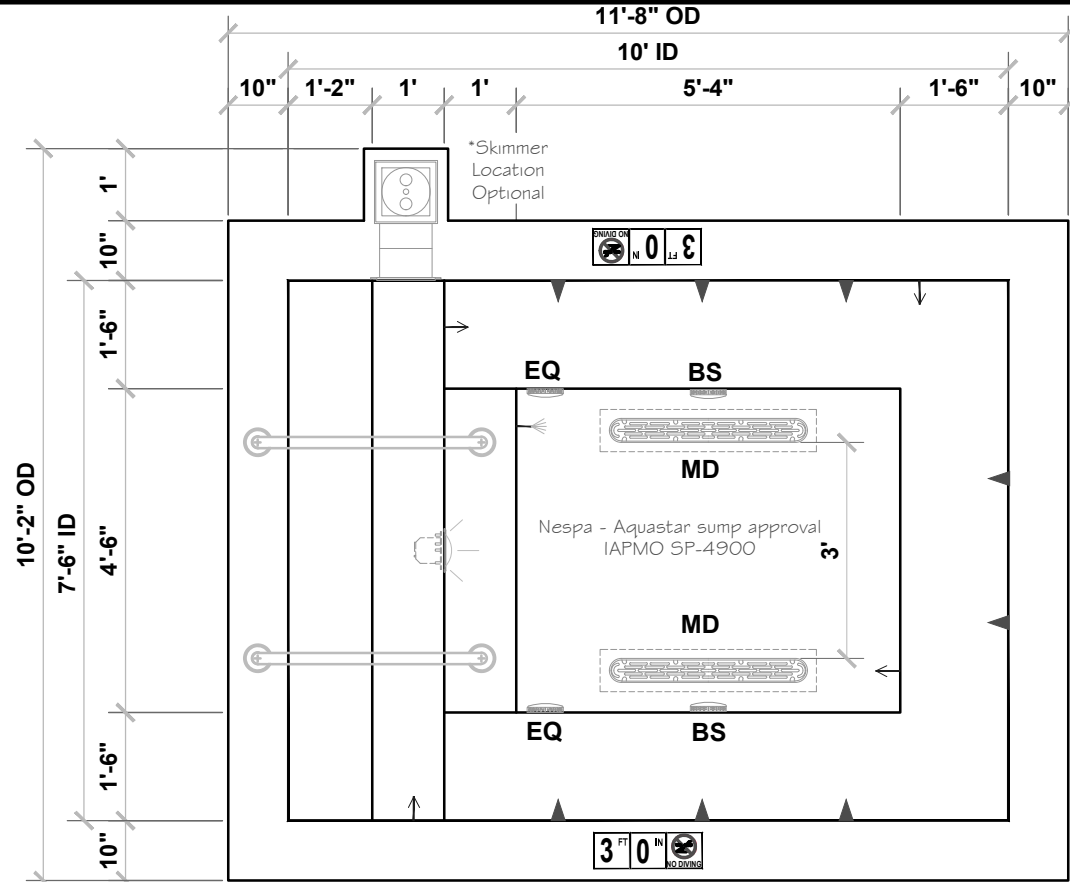









	SKIMMER	1
	MAIN DRAIN	2
	EQUALIZER	2
	B SUCTION	2
	JET	8
	RETURN	3
	WATER FILL	1
	STILLING	-
	VAC	-
	LIGHT	1
WATERPROOF SKID SUPPORT STRUCTURE ATTACHED TO SPA AT NESPA FACTORY   *SKIDS SUPPLIED BY NESPA		



# 12' Legacy MDL# 702-LA

SPECIFICATIONS	
SHELL WEIGHT:	2850 LBS.
WATER WEIGHT:	12756 LBS.
TOTAL SHELL & WATER WEIGHT:	15605.6 LBS.
WATER VOLUME:	204 Cu.Ft.
WATER GALLONS:	1530 GAL.
SURFACE AREA:	90.0 SQ. FT.
SPA LENGTH:	12'-0"
SPA WIDTH:	7'-6"
SPA DEPTH	3'-6"
PEOPLE	9
ICC ES LISTING #	PMG-1161
USPC LISTING #	SP14385

## LEGEND:

	SKIMMER	1
	MAIN DRAIN	2
	EQUALIZER	2
	B SUCTION	2
	JET	10
	RETURN	4
	WATER FILL	1
	STILLING	-
	VAC	-
	LIGHT	1
WATERPROOF SKID SUPPORT STRUCTURE ATTACHED TO SPA AT NESPA FACTORY   *SKIDS SUPPLIED BY NESPA		

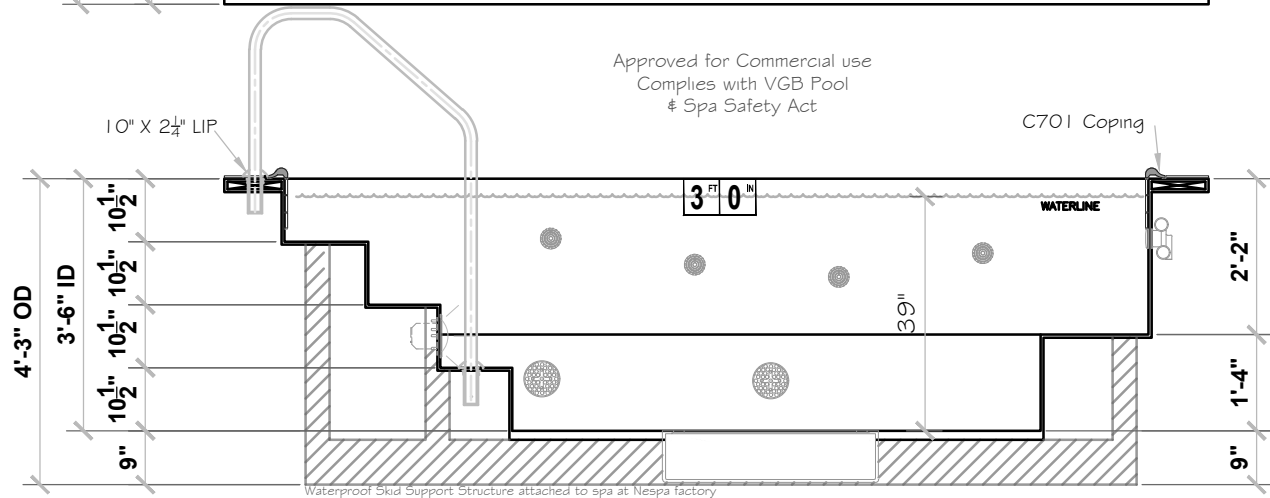
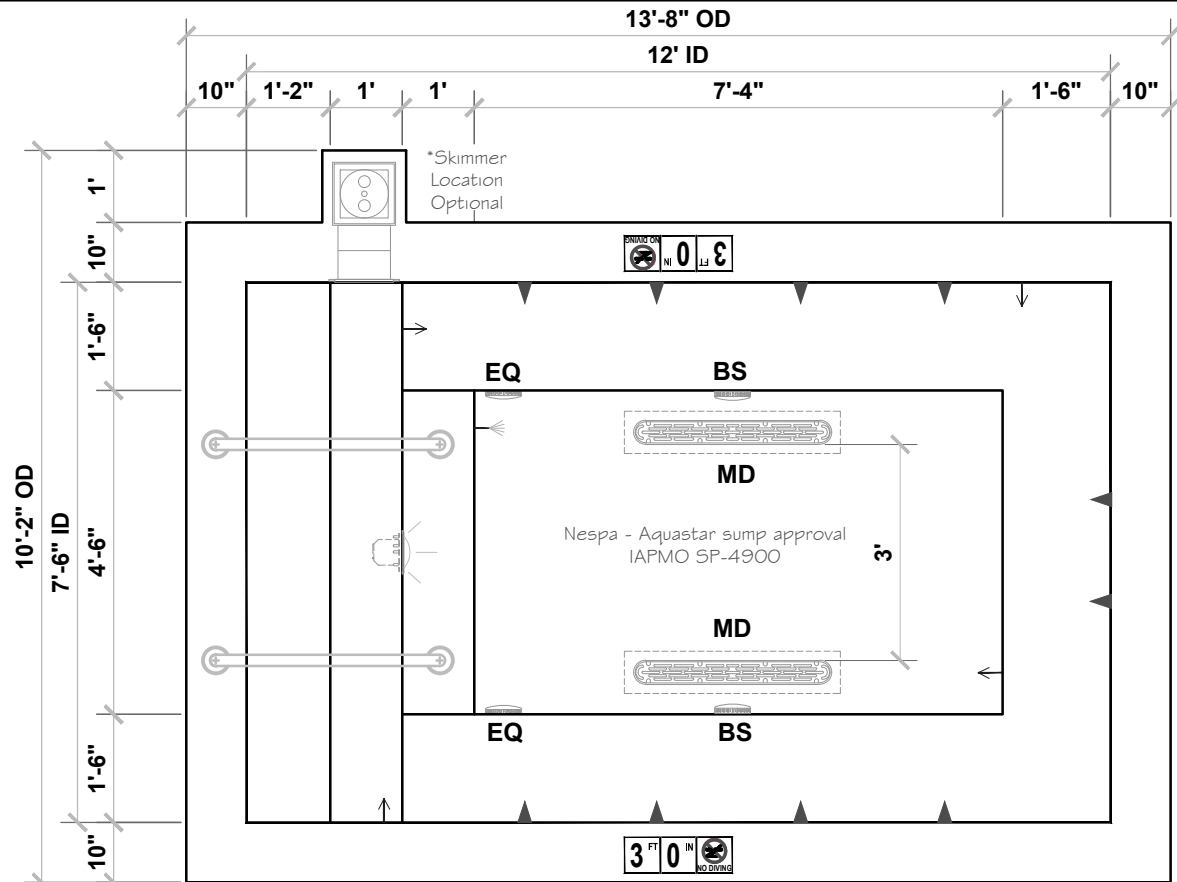

# 14' Legacy

## MDL# 703-LA

SPECIFICATIONS	
SHELL WEIGHT:	3100 LBS.
WATER WEIGHT:	15319 LBS.
TOTAL SHELL & WATER WEIGHT:	18419.2 LBS.
WATER VOLUME:	245 Cu.Ft.
WATER GALLONS:	1838 GAL.
SURFACE AREA:	105.0 SQ. FT.
SPA LENGTH:	14'-0"
SPA WIDTH:	7'-6"
SPA DEPTH	3'-6"
PEOPLE	10
ICC ES LISTING #	PMG-1161
USPC LISTING #	SP14385

### LEGEND:

	SKIMMER	2
	MAIN DRAIN	2
	EQUALIZER	4
	B SUCTION	4
	JET	12
	RETURN	4
	WATER FILL	1
	STILLING	-
	VAC	-
	LIGHT	1
WATERPROOF SKID SUPPORT STRUCTURE ATTACHED TO SPA AT NESPA FACTORY *SKIDS SUPPLIED BY NESPA		

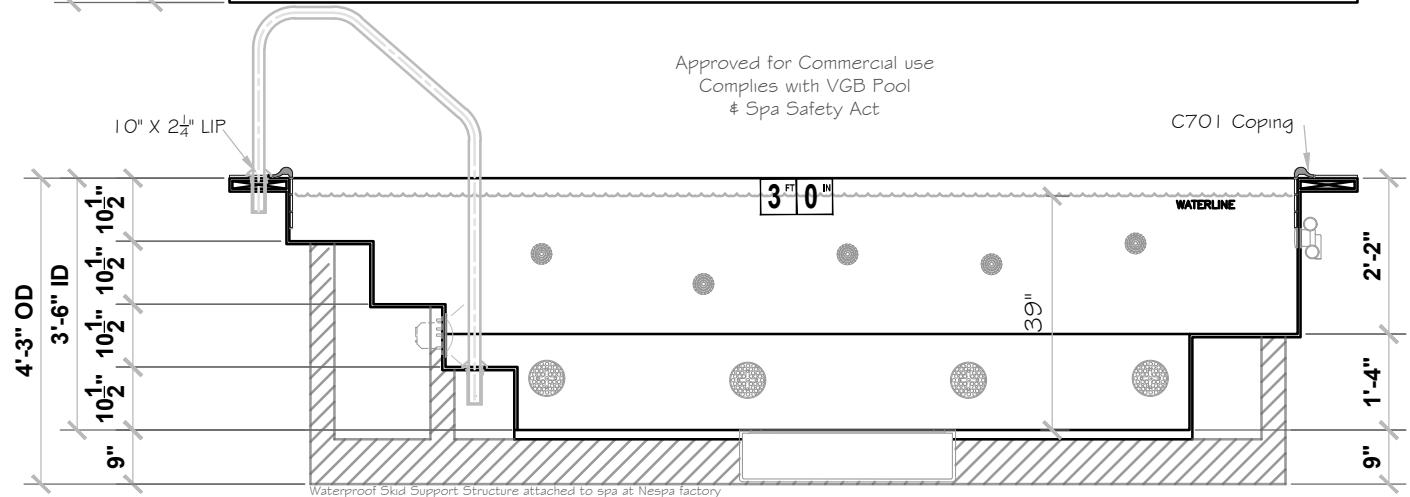
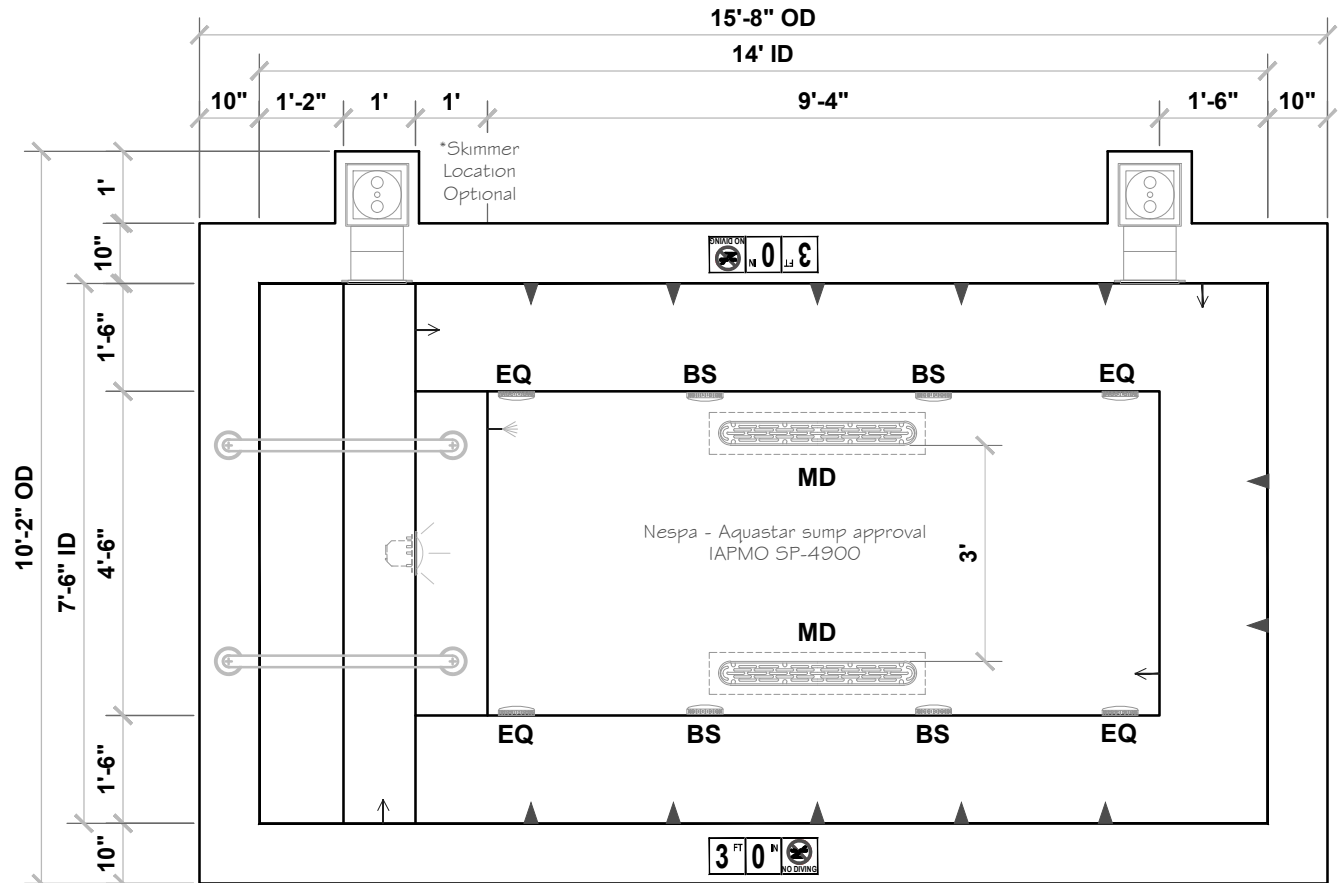



# 16' Legacy

## MDL# 704-LA

SPECIFICATIONS	
SHELL WEIGHT:	3350 LBS.
WATER WEIGHT:	17858 LBS.
TOTAL SHELL & WATER WEIGHT:	21207.9 LBS.
WATER VOLUME:	285.6 Cu.Ft.
WATER GALLONS:	2142 GAL.
SURFACE AREA:	120.0 SQ. FT.
SPA LENGTH:	16'-0"
SPA WIDTH:	7'-6"
SPA DEPTH	3'-6"
PEOPLE	12
ICC ES LISTING #	PMG-1161
USPC LISTING #	SP14385

### LEGEND:

	SKIMMER	2
	MAIN DRAIN	2
	EQUALIZER	4
	B SUCTION	4
	JET	12
	RETURN	4
	WATER FILL	1
	STILLING	-
	VAC	-
	LIGHT	1
WATERPROOF SKID SUPPORT STRUCTURE ATTACHED TO SPA AT NESPA FACTORY *SKIDS SUPPLIED BY NESPA		

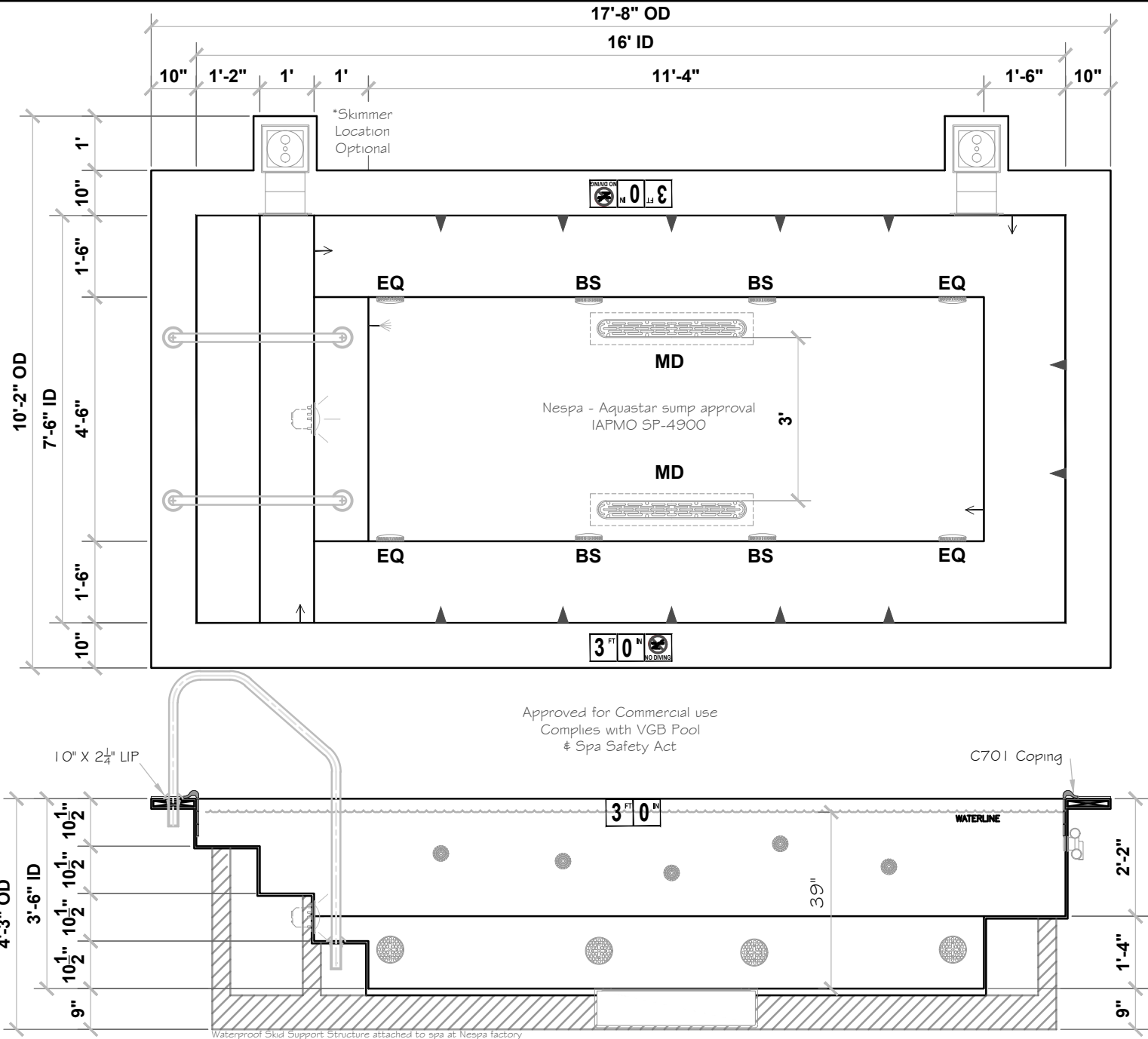

# 18' Legacy

## MDL# 705-LA

SPECIFICATIONS	
SHELL WEIGHT:	3600 LBS.
WATER WEIGHT:	20409 LBS.
TOTAL SHELL & WATER WEIGHT:	24009 LBS.
WATER VOLUME:	326.4 Cu.Ft.
WATER GALLONS:	2448 GAL.
SURFACE AREA:	135.0 SQ. FT.
SPA LENGTH:	18'-0"
SPA WIDTH:	7'-6"
SPA DEPTH	3'-6"
PEOPLE	13
ICC ES LISTING #	PMG-1161
USPC LISTING #	SP14385

### LEGEND:

	SKIMMER	2
	MAIN DRAIN	2
	EQUALIZER	4
	B SUCTION	4
	JET	14
	RETURN	4
	WATER FILL	1
	STILLING	-
	VAC	-
	LIGHT	1
WATERPROOF SKID SUPPORT STRUCTURE ATTACHED TO SPA AT NESPA FACTORY *SKIDS SUPPLIED BY NESPA		

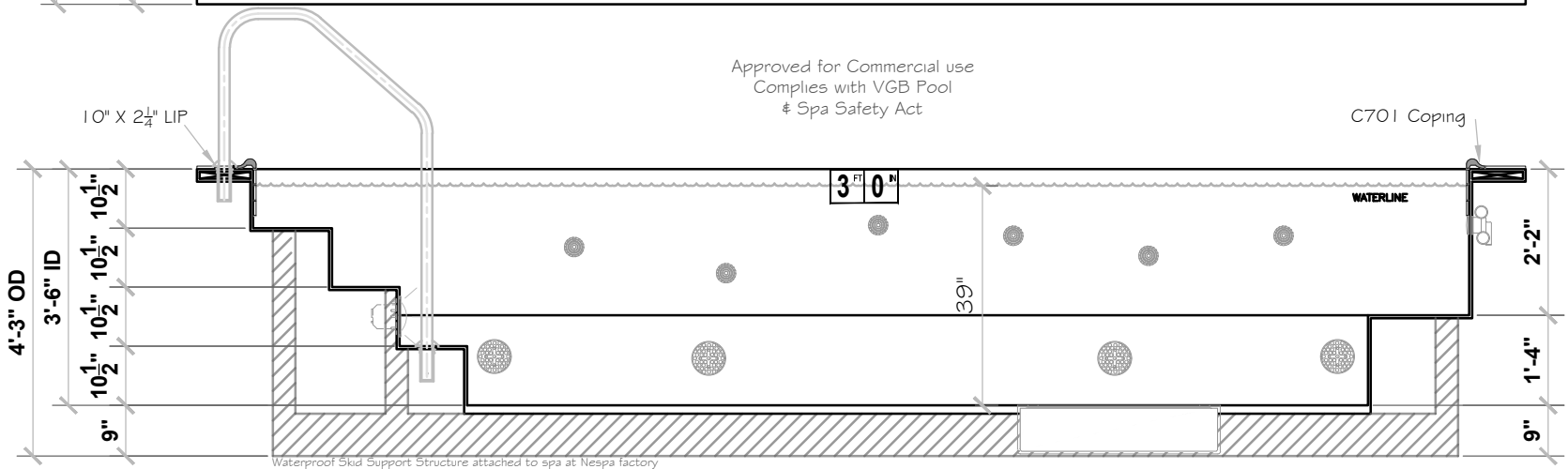
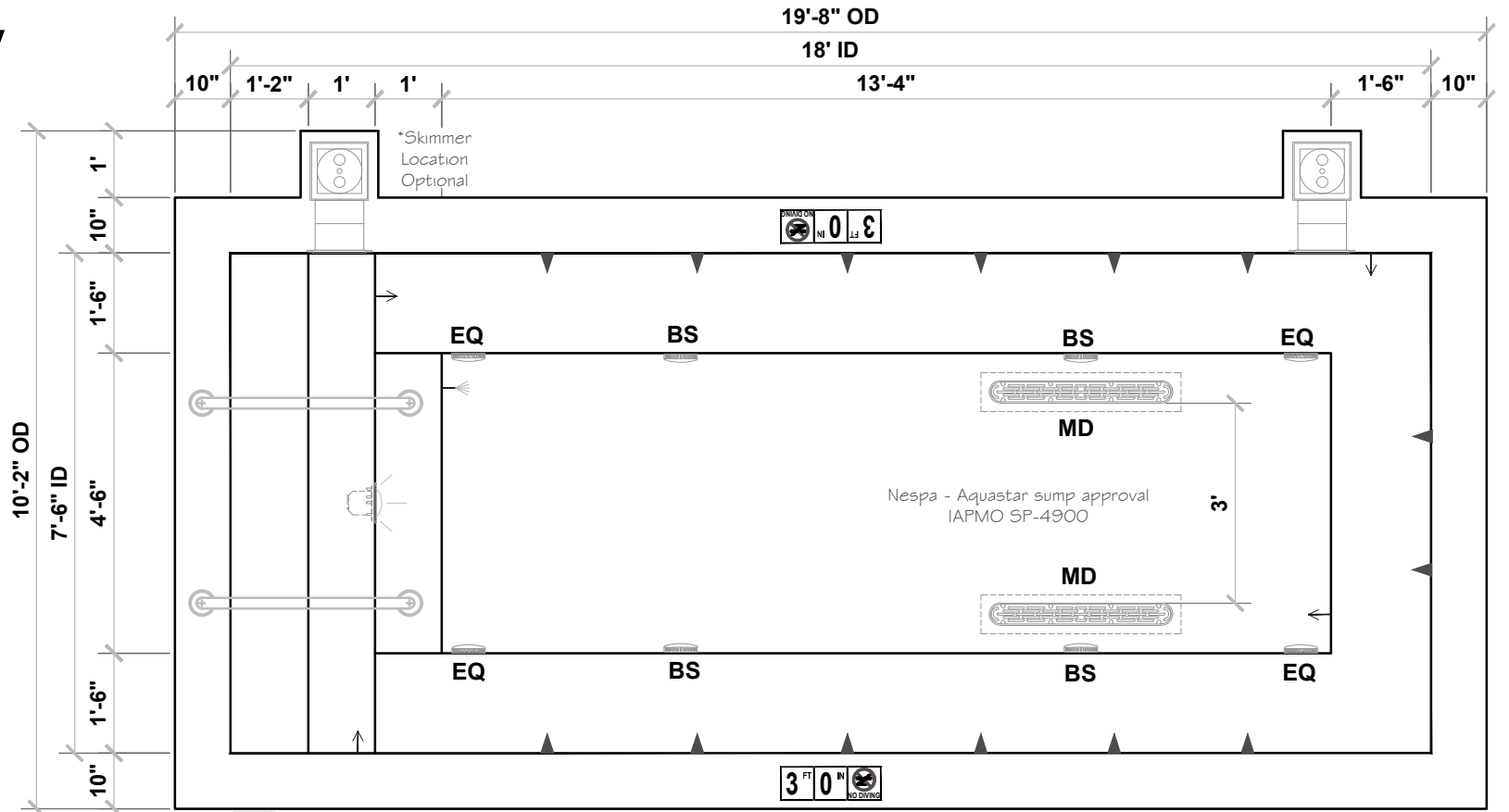

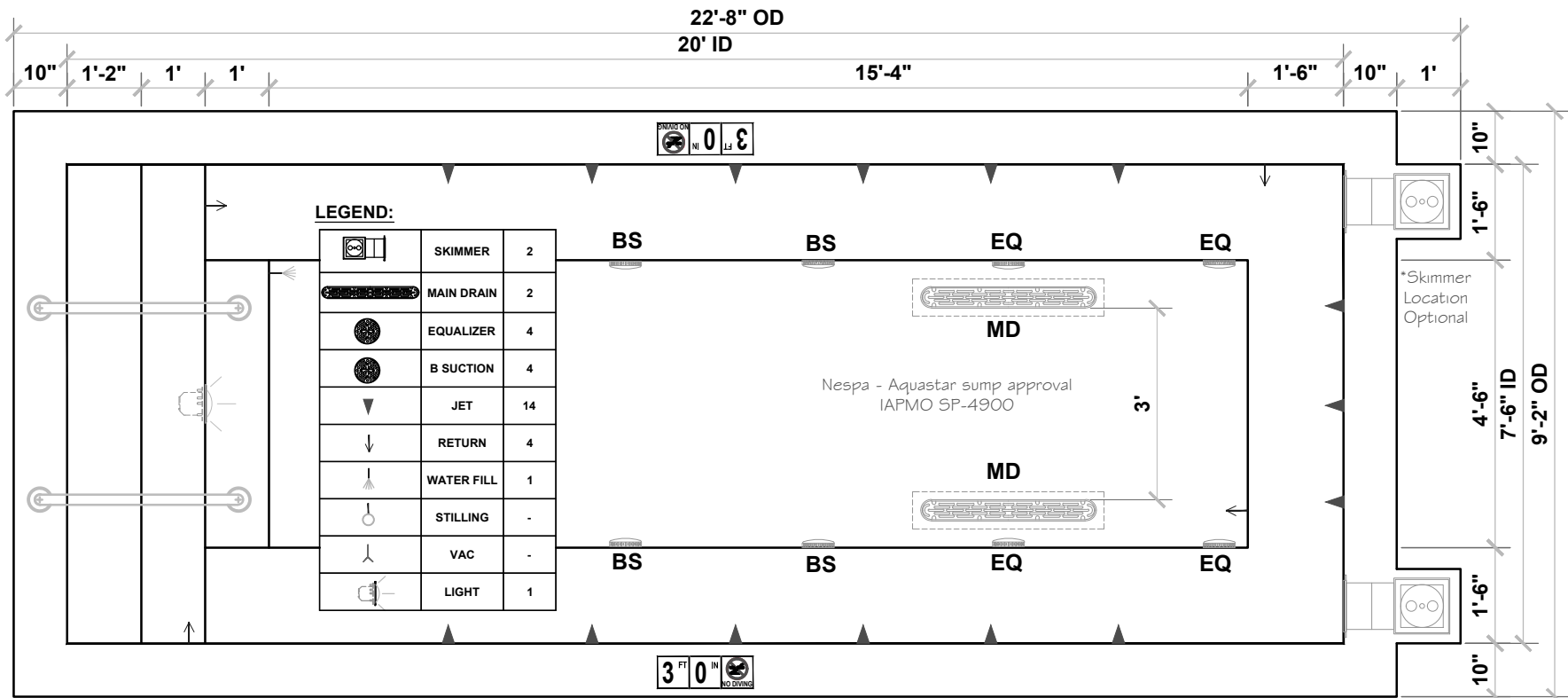

**LEGEND:**

	SKIMMER	2
	MAIN DRAIN	2
	EQUALIZER	4
	B SUCTION	4
	JET	14
	RETURN	4
	WATER FILL	1
	STILLING	-
	VAC	-
	LIGHT	1

Approved for Commercial use  
Complies with VGB Pool & Spa Safety Act

**SPECIFICATIONS**

SHELL WEIGHT:	6000 LBS.
WATER WEIGHT:	20634 LBS.
TOTAL SHELL & WATER WEIGHT:	26634.1 LBS.
WATER VOLUME:	330 Cu.Ft.
WATER GALLONS:	2475 GAL.
SURFACE AREA:	150.0 SQ. FT.
ICC ES LISTED #:	PMG-1161

# 20' Legacy MDL# 706-LA

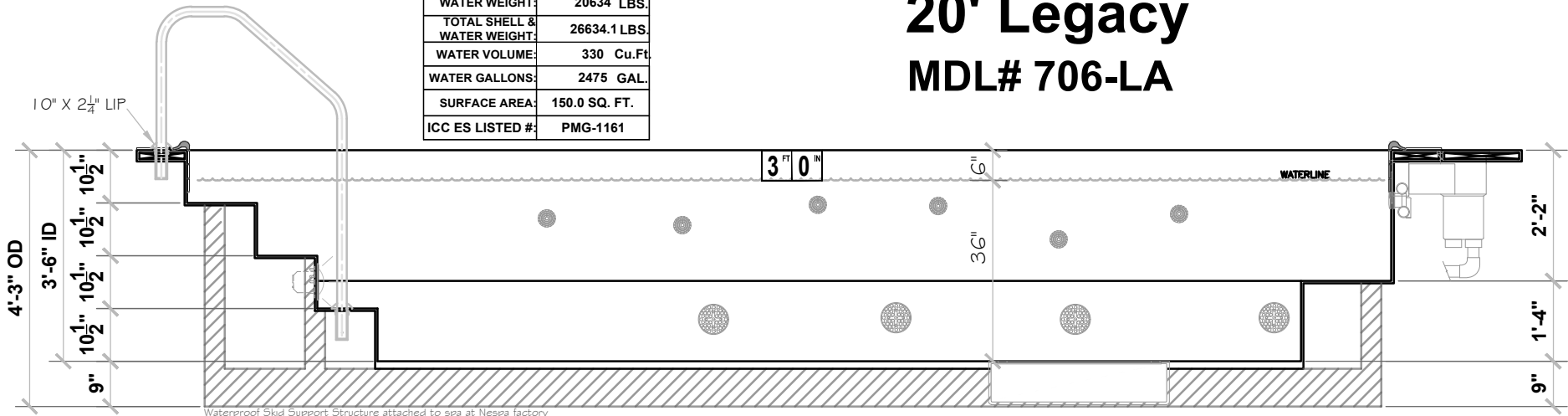

Waterproof Skid Support Structure attached to spa at Nespa factory













# Legacy

## 6.3' x 10.3' CS

### MDL# 7702-LA

SPECIFICATIONS	
SHELL WEIGHT:	2300 LBS.
WATER WEIGHT:	8691 LBS.
TOTAL SHELL & WATER WEIGHT:	10991.3 LBS.
WATER VOLUME:	139 Cu.Ft.
WATER GALLONS:	1043 GAL.
SURFACE AREA:	64.5 SQ. FT.
SPA LENGTH:	10'-4"
SPA WIDTH:	6'-4"
SPA DEPTH:	3'-6"
PEOPLE:	6
ICC ES LISTING #	PMG-1161
USPC LISTING #	SP14385

#### LEGEND:

	SKIMMER	1
	MAIN DRAIN	2
	EQUALIZER	2
	B SUCTION	2
	JET	10
	RETURN	3
	WATER FILL	1
	STILLING	-
	VAC	-
	LIGHT	1
WATERPROOF SKID SUPPORT STRUCTURE ATTACHED TO SPA AT NESPA FACTORY *SKIDS SUPPLIED BY NESPA		

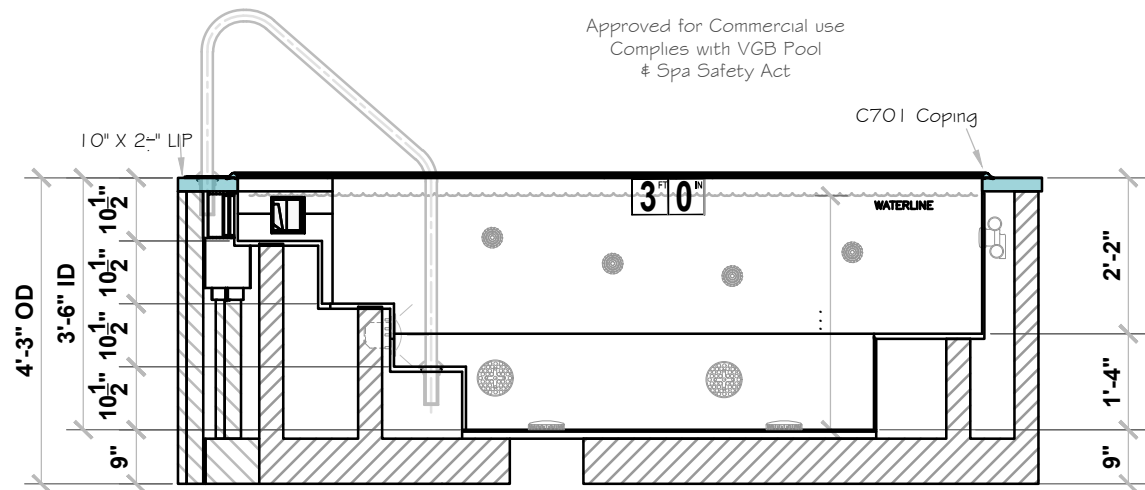
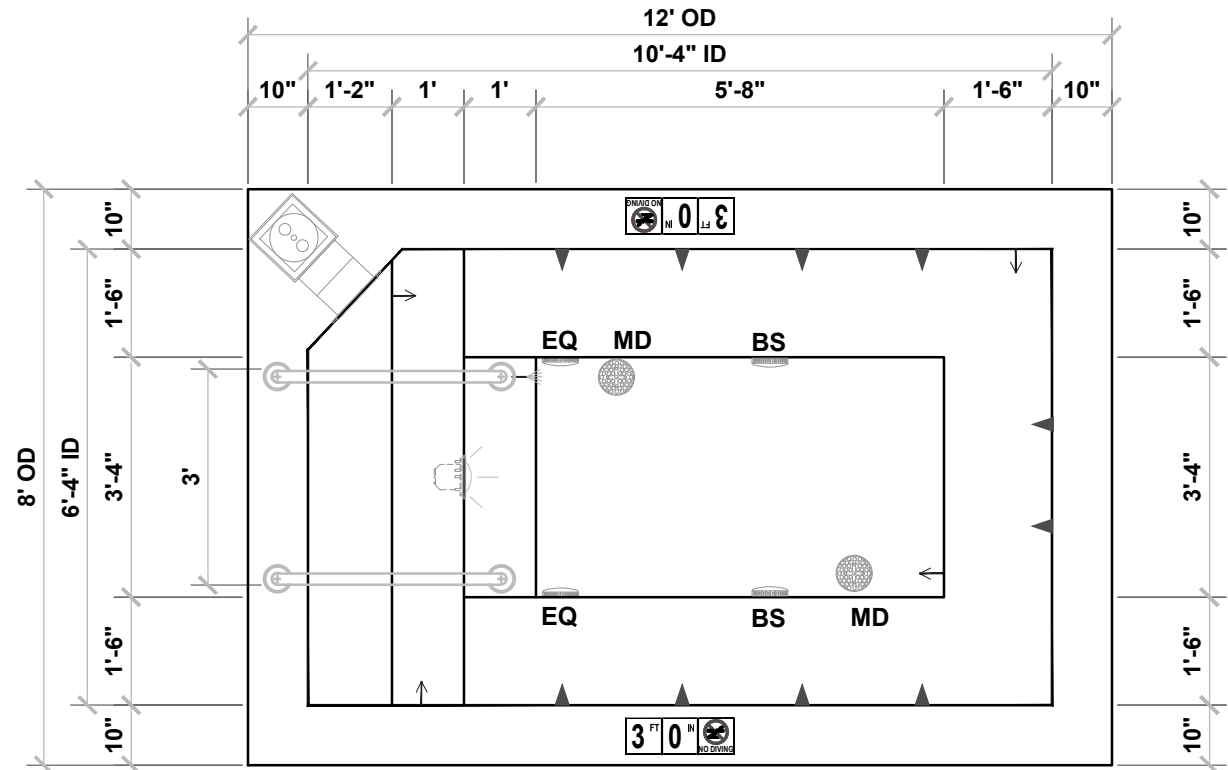

Approved for Commercial use  
Complies with VGB Pool  
& Spa Safety Act



# Legacy 7'-4" x 18' CS MDL# 7704-LA

SPECIFICATIONS	
SHELL WEIGHT:	3300 LBS.
WATER WEIGHT:	19759 LBS.
TOTAL SHELL & WATER WEIGHT:	23058.7 LBS.
WATER VOLUME:	316 Cu.Fl.
WATER GALLONS:	2370 GAL.
SURFACE AREA:	125.4 SQ. FT.
SPA LENGTH:	17'-10"
SPA WIDTH:	7'-4"
SPA DEPTH:	3'-6"
PEOPLE:	12
ICC ES LISTING #	PMG-1161
USPC LISTING #	SP14385

### LEGEND:

	SKIMMER	2
	MAIN DRAIN	2
	EQUALIZER	4
	B SUCTION	4
	JET	15
	RETURN	4
	WATER FILL	1
	STILLING	-
	VAC	-
	LIGHT	1
WATERPROOF SKID SUPPORT STRUCTURE ATTACHED TO SPA AT NESPA FACTORY *SKIDS SUPPLIED BY NESPA		

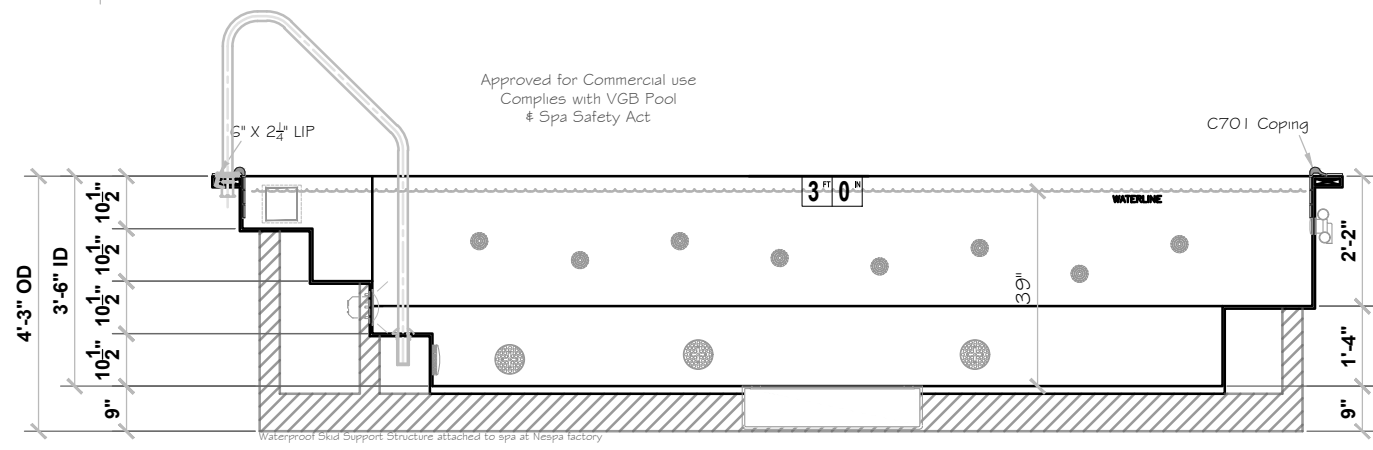
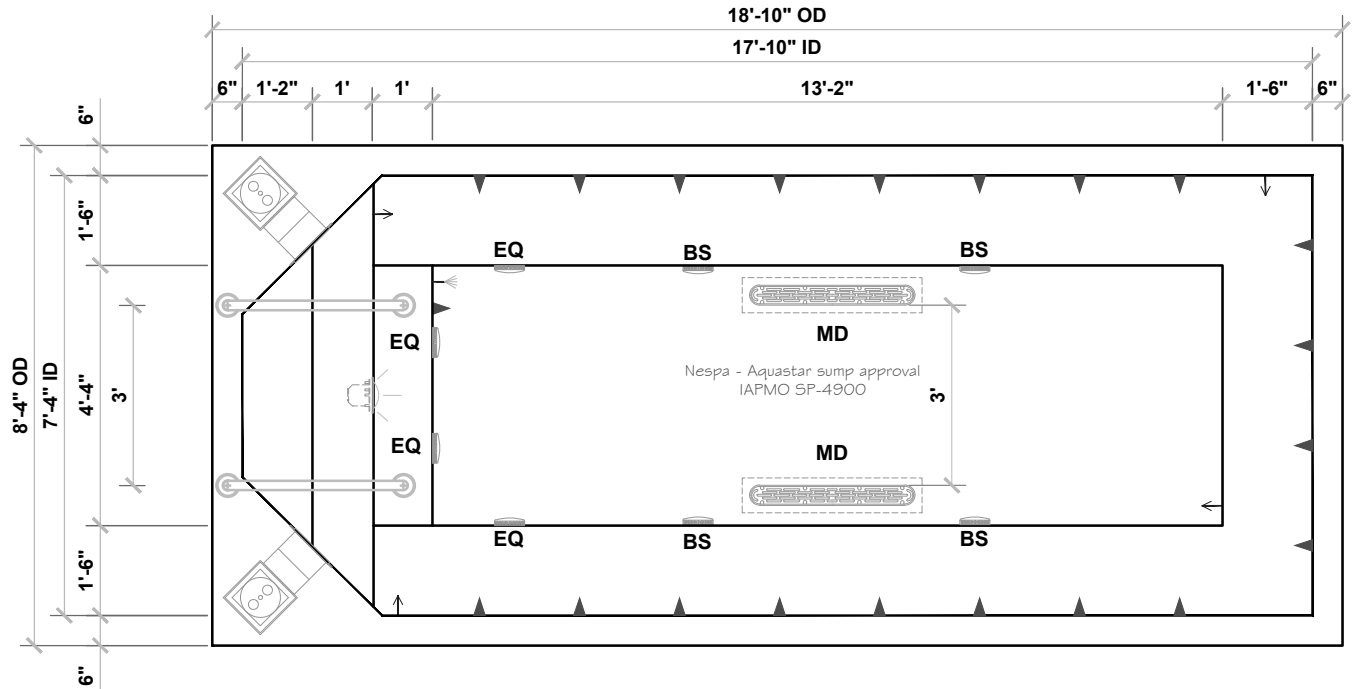

# Legacy 7.5' x 16' CS MDL# 7703-LA

SPECIFICATIONS	
SHELL WEIGHT:	3300 LBS.
WATER WEIGHT:	18008 LBS.
TOTAL SHELL & WATER WEIGHT:	21307.9 LBS.
WATER VOLUME:	288 Cu.Ft.
WATER GALLONS:	2160 GAL.
SURFACE AREA:	118.1 SQ. FT.
SPA LENGTH:	16'-0"
SPA WIDTH:	7'-6"
SPA DEPTH:	3'-6"
PEOPLE	11
ICC ES LISTING #	PMG-1161
USPC LISTING #	SP14385

## LEGEND:

	SKIMMER	2
	MAIN DRAIN	2
	EQUALIZER	4
	B SUCTION	4
	JET	15
	RETURN	4
	WATER FILL	1
	STILLING	-
	VAC	-
	LIGHT	1
WATERPROOF SKID SUPPORT STRUCTURE ATTACHED TO SPA AT NESPA FACTORY *SKIDS SUPPLIED BY NESPA		

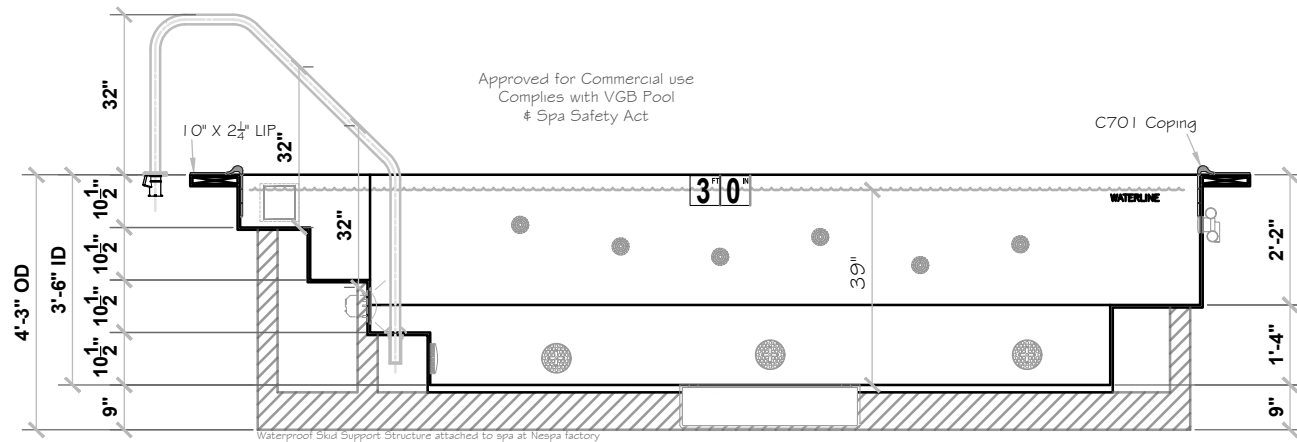
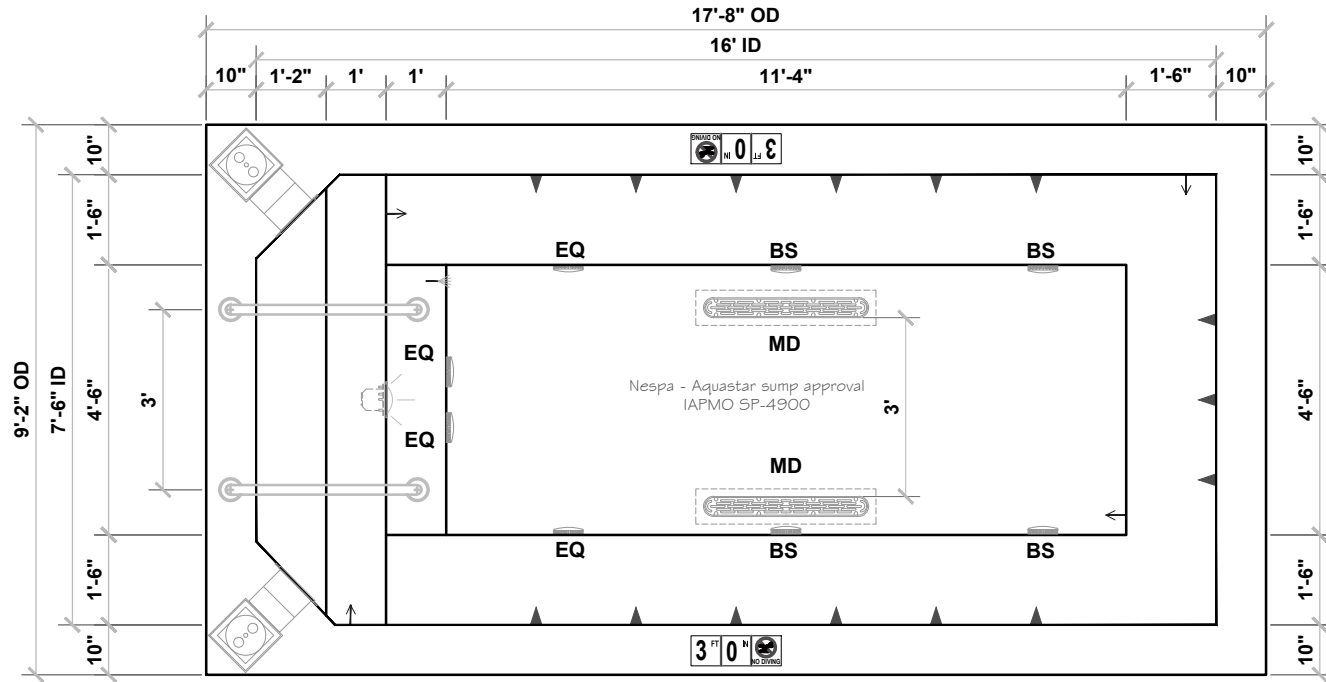

# Legacy 8' x 12' CS MDL# 7804-LA

SPECIFICATIONS	
SHELL WEIGHT:	2600 LBS.
WATER WEIGHT:	13631 LBS.
TOTAL SHELL & WATER WEIGHT:	16231 LBS.
WATER VOLUME:	218 Cu.Ft.
WATER GALLONS:	1635 GAL.
SURFACE AREA:	93.3 SQ. FT.
SPA LENGTH:	12'-0"
SPA WIDTH:	8'-0"
SPA DEPTH	3'-6"
PEOPLE	9
ICC ES LISTING #	PMG-1161
USPC LISTING #	SP14385

### LEGEND:

	SKIMMER	2
	MAIN DRAIN	2
	EQUALIZER	4
	B SUCTION	2
	JET	10
	RETURN	3
	WATER FILL	1
	STILLING	-
	VAC	-
	LIGHT	1
WATERPROOF SKID SUPPORT STRUCTURE ATTACHED TO SPA AT NESPA FACTORY *SKIDS SUPPLIED BY NESPA		

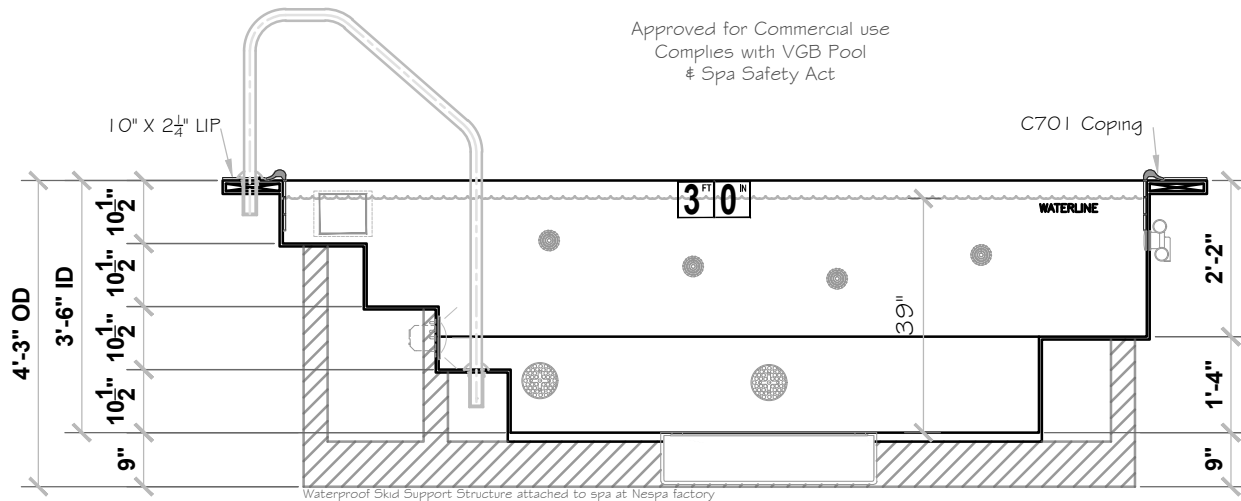
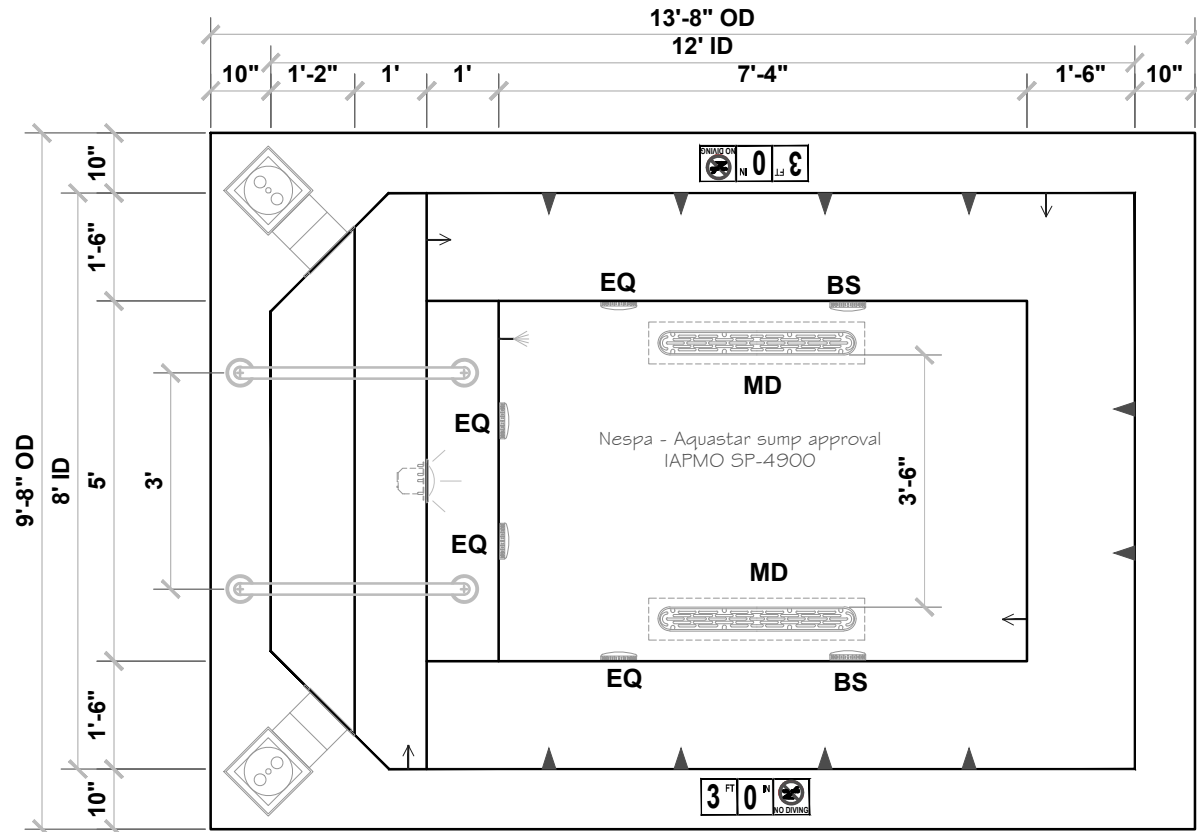

# Legacy 8' x 12' DSA MDL# 7814-LA

SPECIFICATIONS	
SHELL WEIGHT:	3400 LBS.
WATER WEIGHT:	13443 LBS.
TOTAL SHELL & WATER WEIGHT:	16843.4 LBS.
WATER VOLUME:	215 Cu.Ft.
WATER GALLONS:	1613 GAL.
SURFACE AREA:	90.6 SQ. FT.
SPA LENGTH:	12'-0"
SPA WIDTH:	8'-0"
SPA DEPTH:	3'-6"
PEOPLE:	9
CC ES LISTING #	PMG-1161
USPC LISTING #	SP14385

### LEGEND:

	SKIMMER	2
	MAIN DRAIN	2
	EQUALIZER	4
	B SUCTION	2
	JET	10
	RETURN	3
	WATER FILL	1
	STILLING	-
	VAC	-
	LIGHT	1

WATERPROOF SKID SUPPORT STRUCTURE ATTACHED TO SPA AT NESPA FACTORY

\*SKIDS SUPPLIED BY NESPA

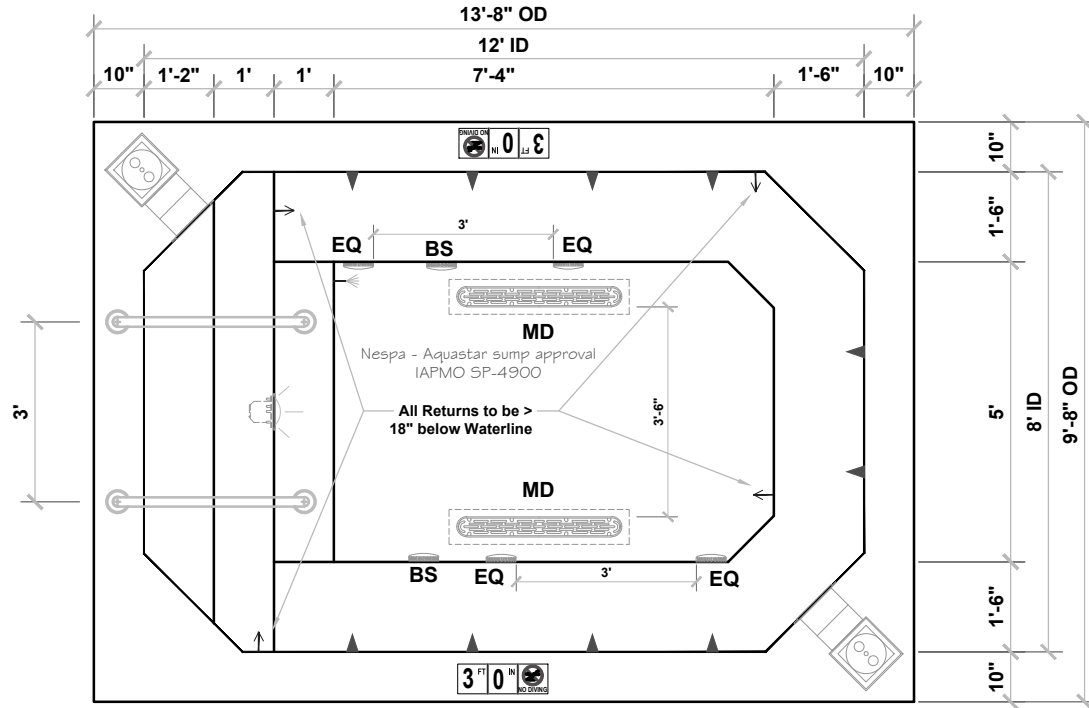

Approved for Commercial use  
Complies with VGB Pool  
\* Spa Safety Act

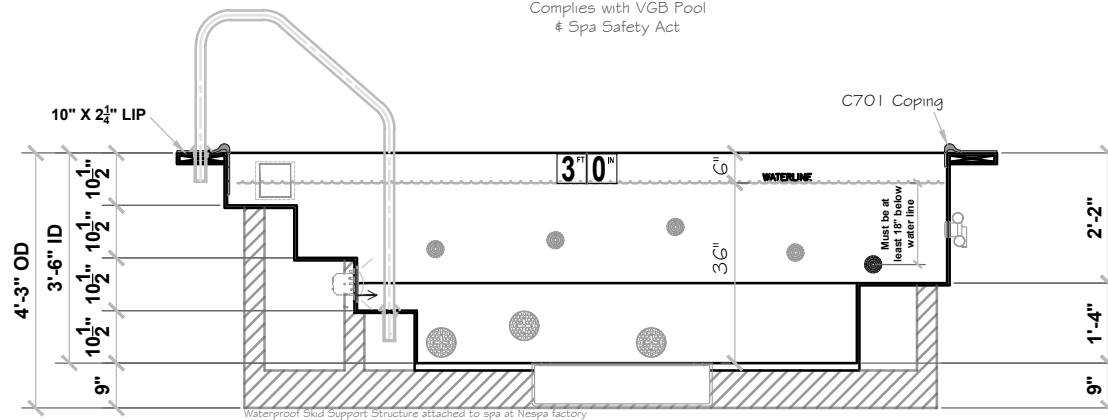



# Legacy 8' x 14' DSA MDL# 7815-LA

SPECIFICATIONS	
SHELL WEIGHT:	3800 LBS.
WATER WEIGHT:	16257 LBS.
TOTAL SHELL & WATER WEIGHT:	20057.2 LBS.
WATER VOLUME:	260 Cu.Ft.
WATER GALLONS:	1950 GAL.
SURFACE AREA:	106.6 SQ. FT.
SPA LENGTH:	14'-0"
SPA WIDTH:	8'-0"
SPA DEPTH:	3'-6"
PEOPLE:	10
ICC ES LISTING #	PMG-1161
USPC LISTING #	SP14385

### LEGEND:

	SKIMMER	2
	MAIN DRAIN	2
	EQUALIZER	4
	B SUCTION	2
	JET	10
	RETURN	4
	WATER FILL	1
	STILLING	-
	VAC	-
	LIGHT	1
WATERPROOF SKID SUPPORT STRUCTURE ATTACHED TO SPA AT NESPA FACTORY SKIDS SUPPLIED BY NESPA		

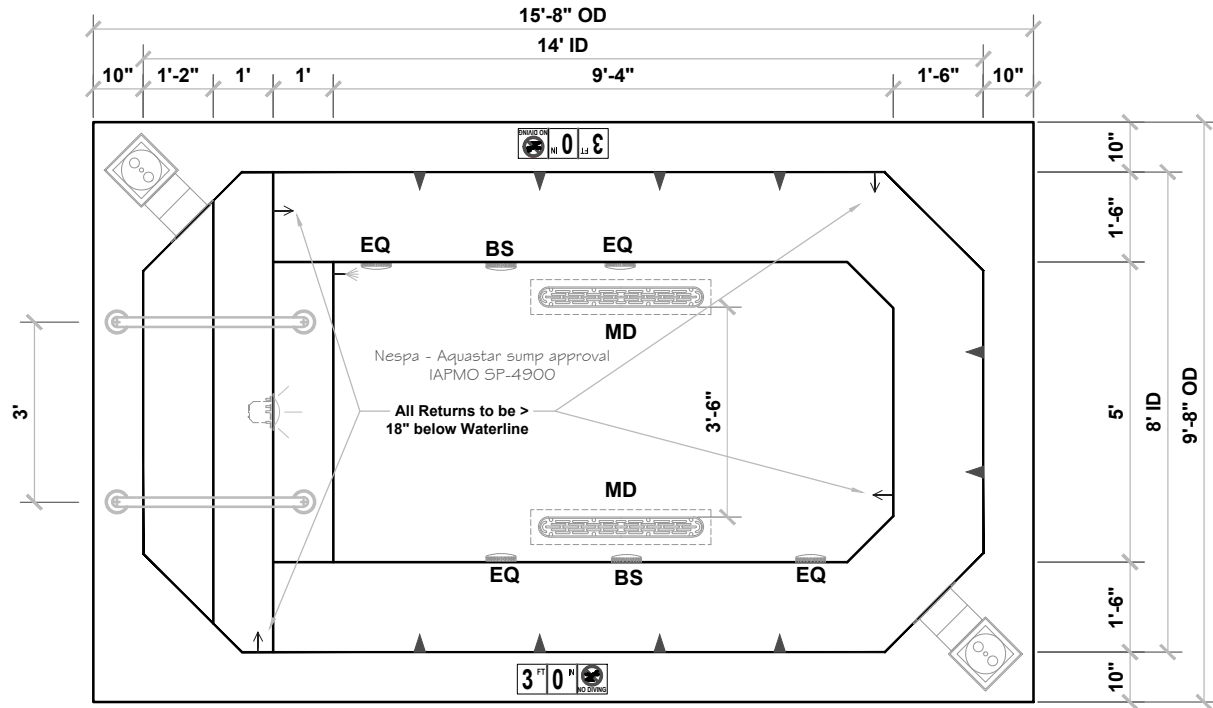

Approved for Commercial use  
Complies with VGB Pool  
& Spa Safety Act

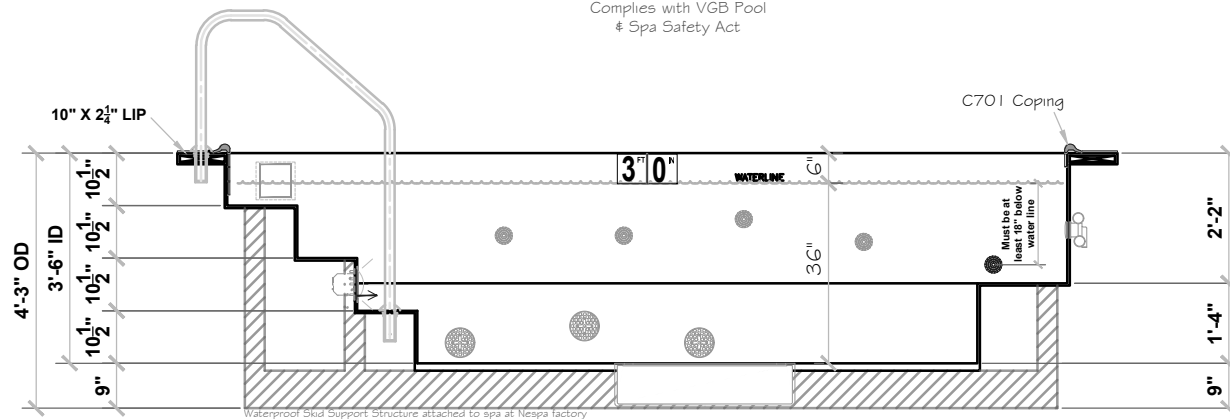

# Legacy

## 8' x 15' CS

### MDL# 7808-LA

SPECIFICATIONS	
SHELL WEIGHT:	3300 LBS.
WATER WEIGHT:	17758 LBS.
TOTAL SHELL & WATER WEIGHT:	21057.8 LBS.
WATER VOLUME:	284 Cu.Ft.
WATER GALLONS:	2130 GAL.
SURFACE AREA:	117.3 SQ. FT.
SPA LENGTH:	15'-0"
SPA WIDTH:	8'-0"
SPA DEPTH:	3'-6"
PEOPLE	11
ICC ES LISTING #	PMG-1161
USPC LISTING #	SP14385

#### LEGEND:

	SKIMMER	2
	MAIN DRAIN	2
	EQUALIZER	4
	B SUCTION	2
	JET	15
	RETURN	4
	WATER FILL	1
	STILLING	-
	VAC	-
	LIGHT	1
WATERPROOF SKID SUPPORT STRUCTURE ATTACHED TO SPA AT NESPA FACTORY *SKIDS SUPPLIED BY NESPA		

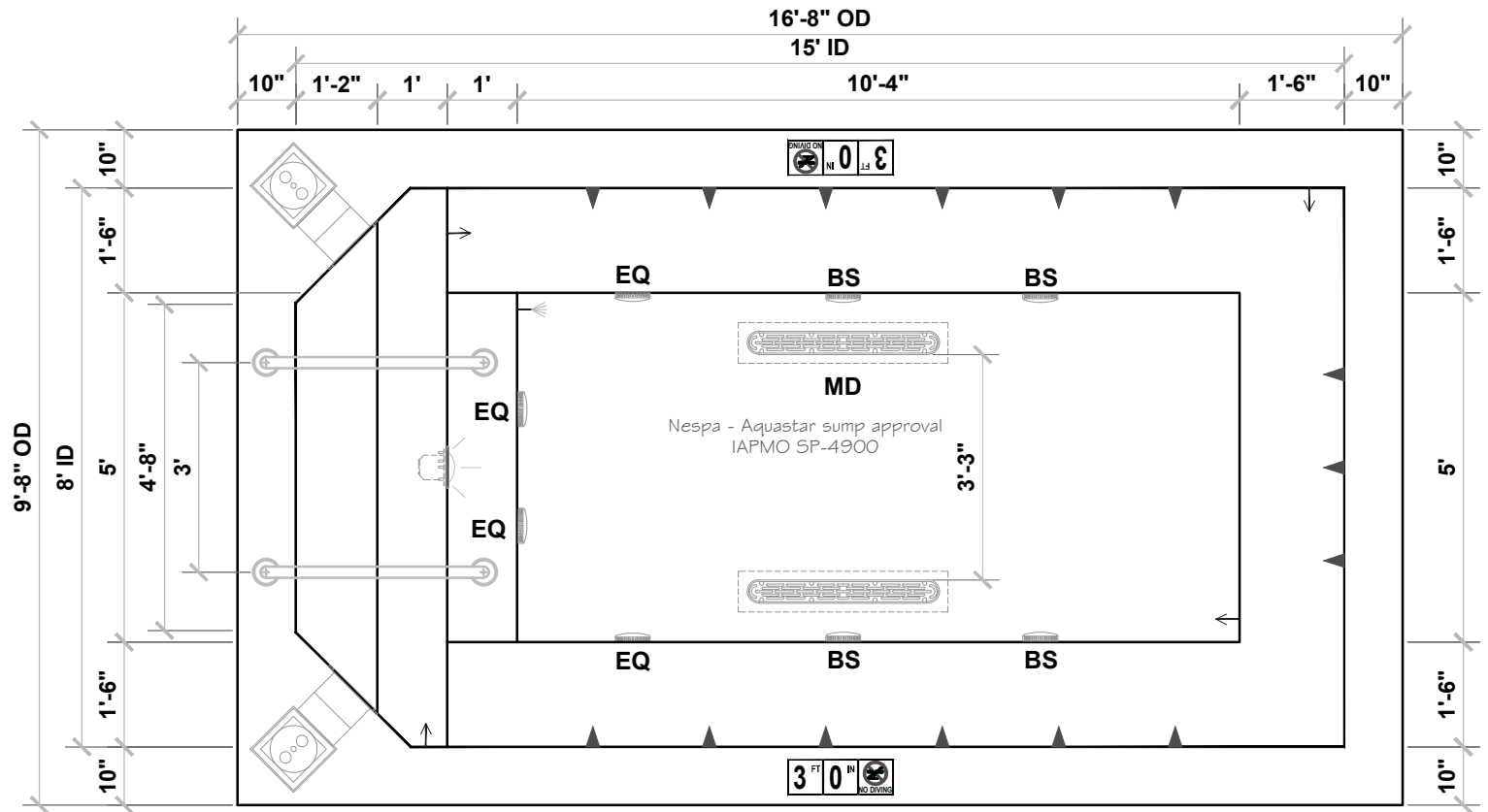

Approved for Commercial use  
Complies with VGB Pool  
& Spa Safety Act

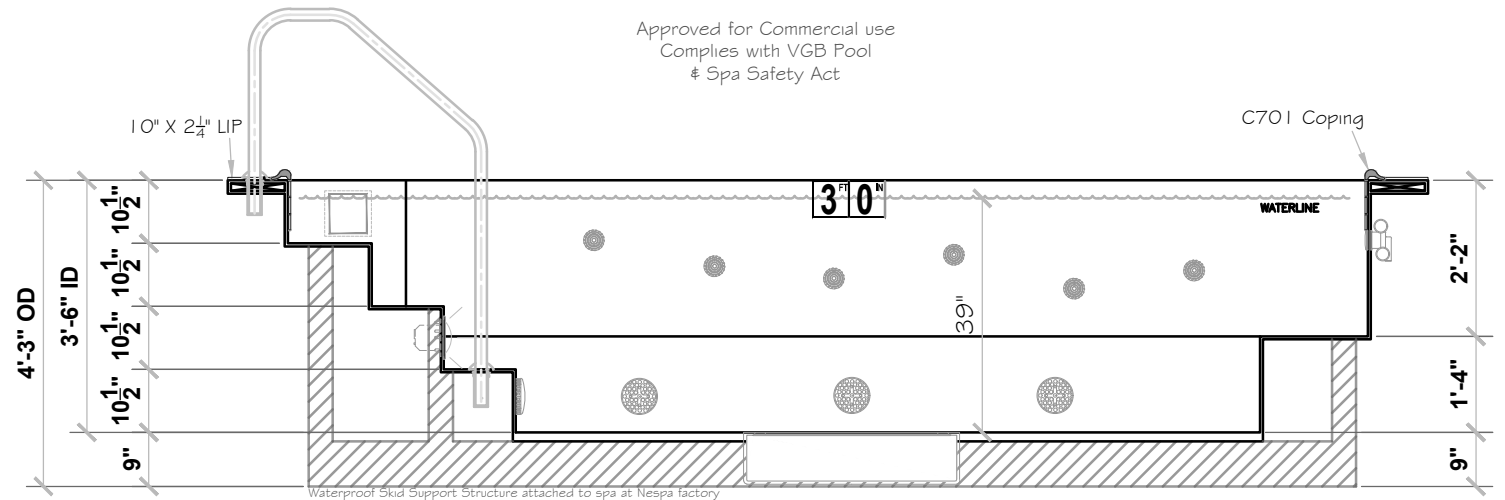

# Legacy 8' x 16' DSA MDL# 7816-LA

SPECIFICATIONS	
SHELL WEIGHT:	4200 LBS.
WATER WEIGHT:	19071 LBS.
TOTAL SHELL & WATER WEIGHT:	23270.9 LBS.
WATER VOLUME:	305 Cu.Ft.
WATER GALLONS:	2288 GAL.
SURFACE AREA:	122.6 SQ. FT.
SPA LENGTH:	16'-0"
SPA WIDTH:	8'-0"
SPA DEPTH	3'-6"
PEOPLE	12
ICC ES LISTING #	PMG-1161
USPC LISTING #	SP14385

## LEGEND:

	SKIMMER	2
	MAIN DRAIN	2
	EQUALIZER	4
	B SUCTION	4
	JET	12
	RETURN	4
	WATER FILL	1
	STILLING	-
	VAC	-
	LIGHT	1

WATERPROOF SKID SUPPORT STRUCTURE ATTACHED TO SPA AT NESPA FACTORY

\*SKIDS SUPPLIED BY NESPA

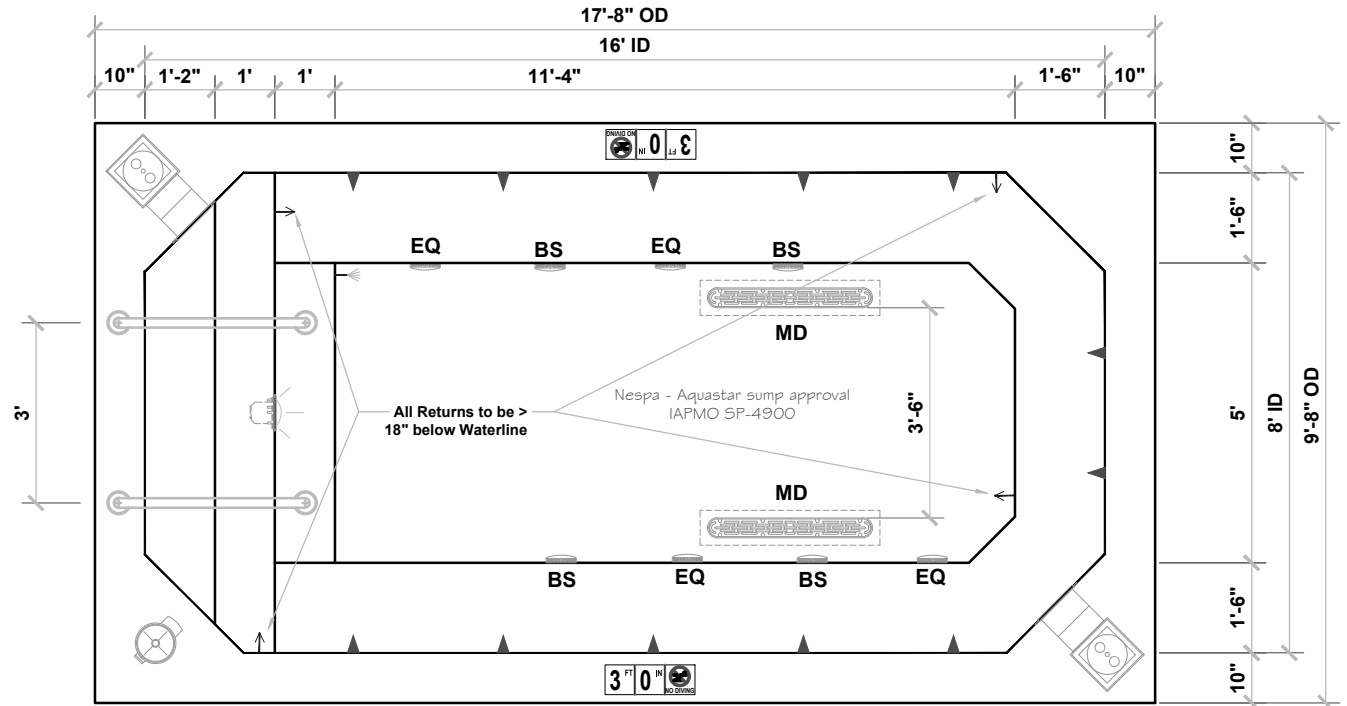

Approved for Commercial use  
Complies with VGB Pool  
& Spa Safety Act

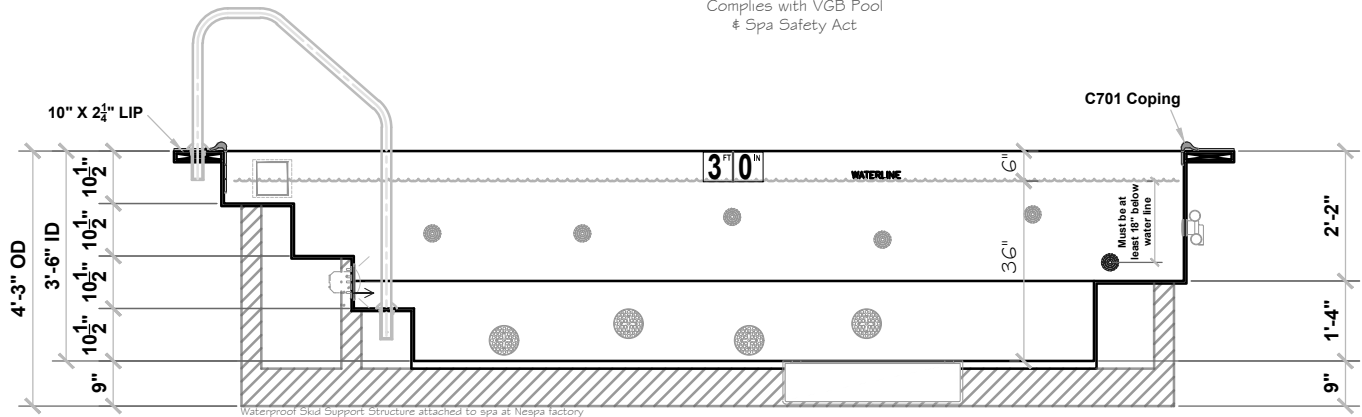

# Legacy 8' x 18' DSA MDL# 7817-LA

SPECIFICATIONS	
SHELL WEIGHT:	4800 LBS.
WATER WEIGHT:	21760 LBS.
TOTAL SHELL & WATER WEIGHT:	26559.6 LBS.
WATER VOLUME:	348 Cu.Ft.
WATER GALLONS:	2610 GAL.
SURFACE AREA:	138.6 SQ. FT.
SPA LENGTH:	18'-0"
SPA WIDTH:	8'-0"
SPA DEPTH:	3'-6"
PEOPLE:	13
ICC ES LISTING #	PMG-1161
USPC LISTING #	SP14385

## LEGEND:

	SKIMMER	2
	MAIN DRAIN	2
	EQUALIZER	4
	B SUCTION	4
	JET	12
	RETURN	4
	WATER FILL	1
	STILLING	-
	VAC	-
	LIGHT	1

WATERPROOF SKID SUPPORT STRUCTURE ATTACHED TO SPA AT NESPA FACTORY

\*SKIDS SUPPLIED BY NESPA

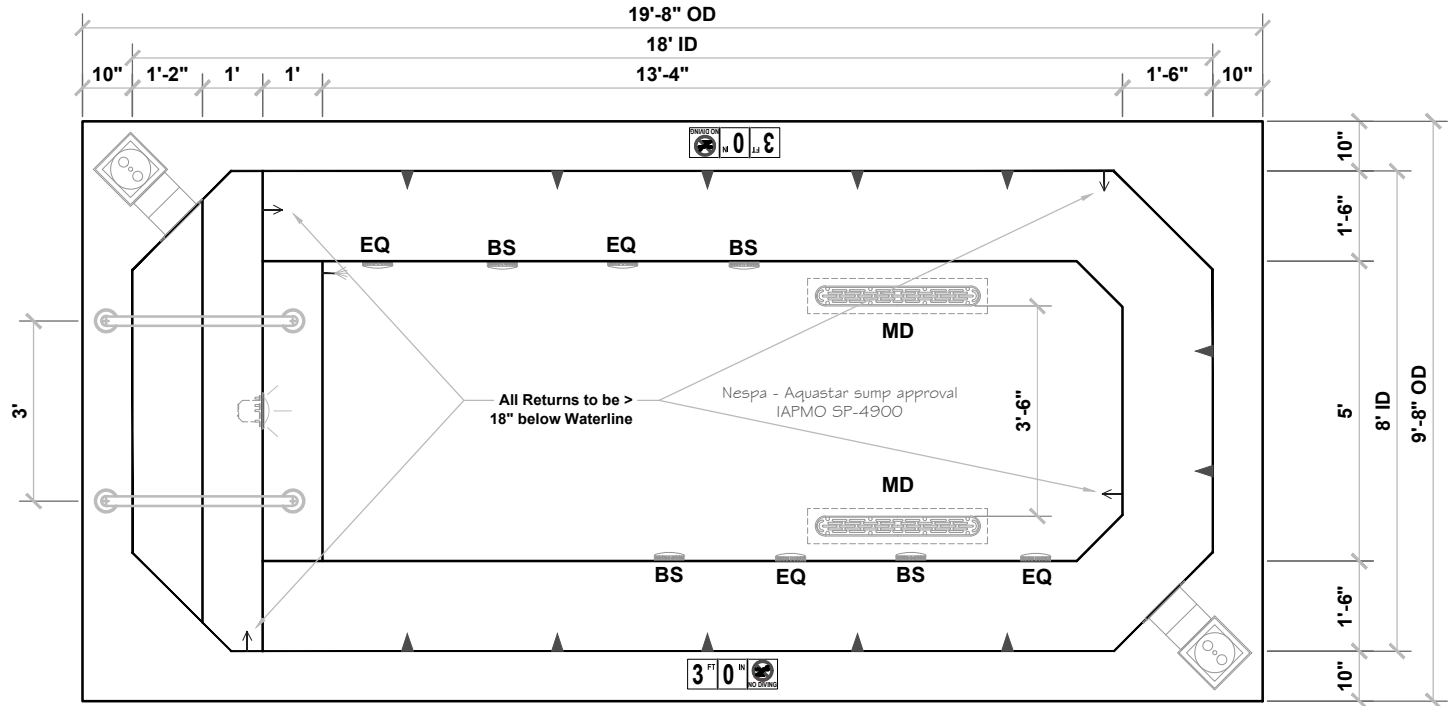

Approved for Commercial use  
Complies with VGB Pool  
& Spa Safety Act

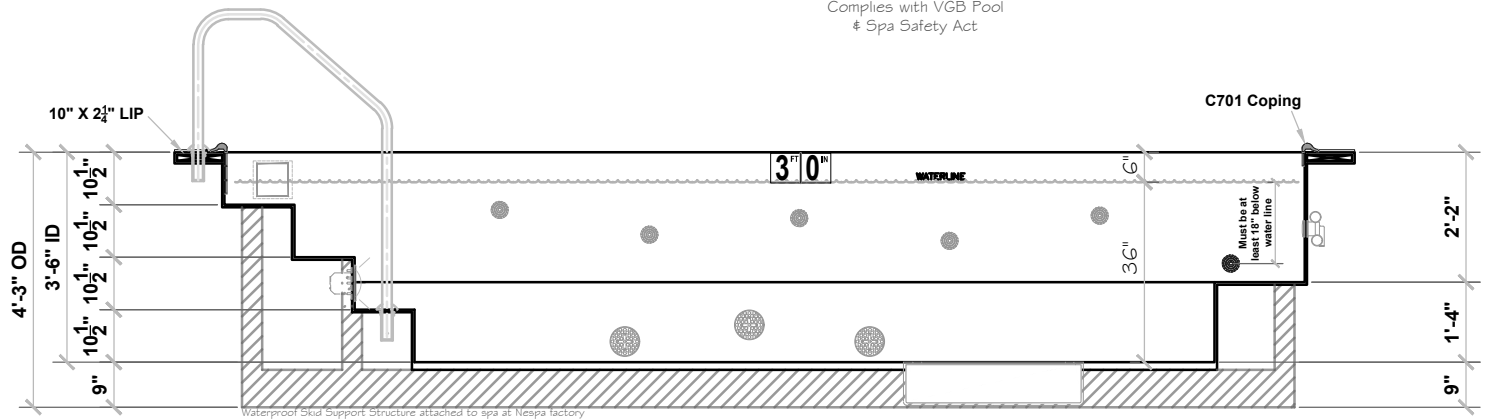

# Legacy 8' x 20' DS MDL# 7812-LA

SPECIFICATIONS	
SHELL WEIGHT:	4200 LBS.
WATER WEIGHT:	22072 LBS.
TOTAL SHELL & WATER WEIGHT:	26272.2 LBS.
WATER VOLUME:	353 Cu.Ft.
WATER GALLONS:	2648 GAL.
SURFACE AREA:	154.6 SQ. FT.
SPA LENGTH:	20'-0"
SPA WIDTH:	8'-0"
SPA DEPTH:	3'-6"
PEOPLE:	15
ICC ES LISTING #:	PMG-1161
USPC LISTING #:	SP14385

## LEGEND:

	SKIMMER	2
	MAIN DRAIN	2
	EQUALIZER	4
	B SUCTION	2
	JET	13
	RETURN	4
	WATER FILL	1
	STILLING	-
	VAC	-
	LIGHT	1
WATERPROOF SKID SUPPORT STRUCTURE ATTACHED TO SPA AT NESPA FACTORY *SKIDS SUPPLIED BY NESPA		

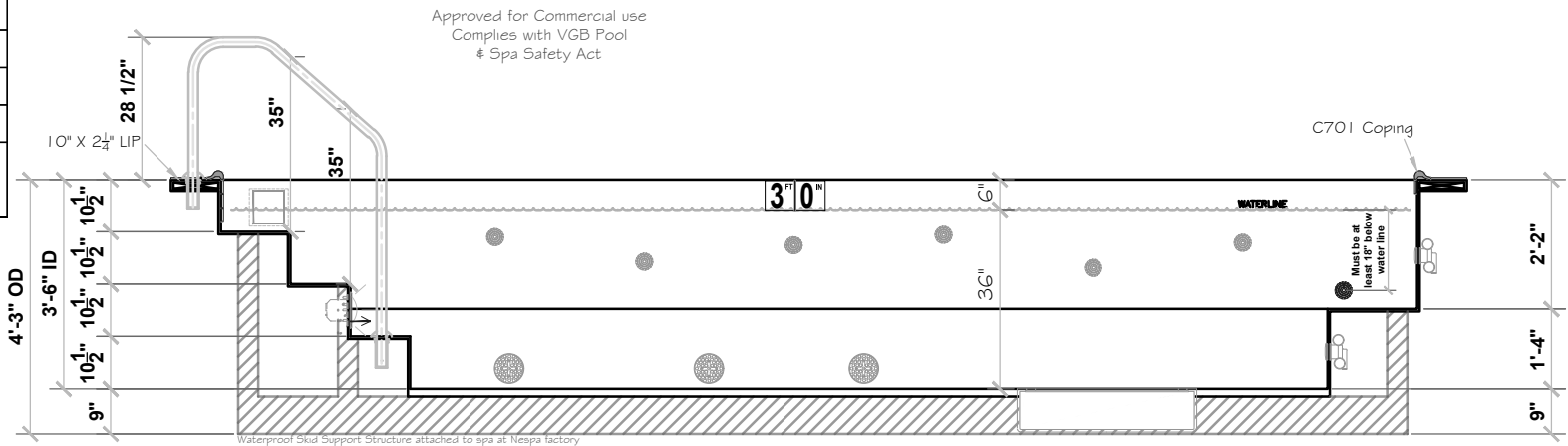
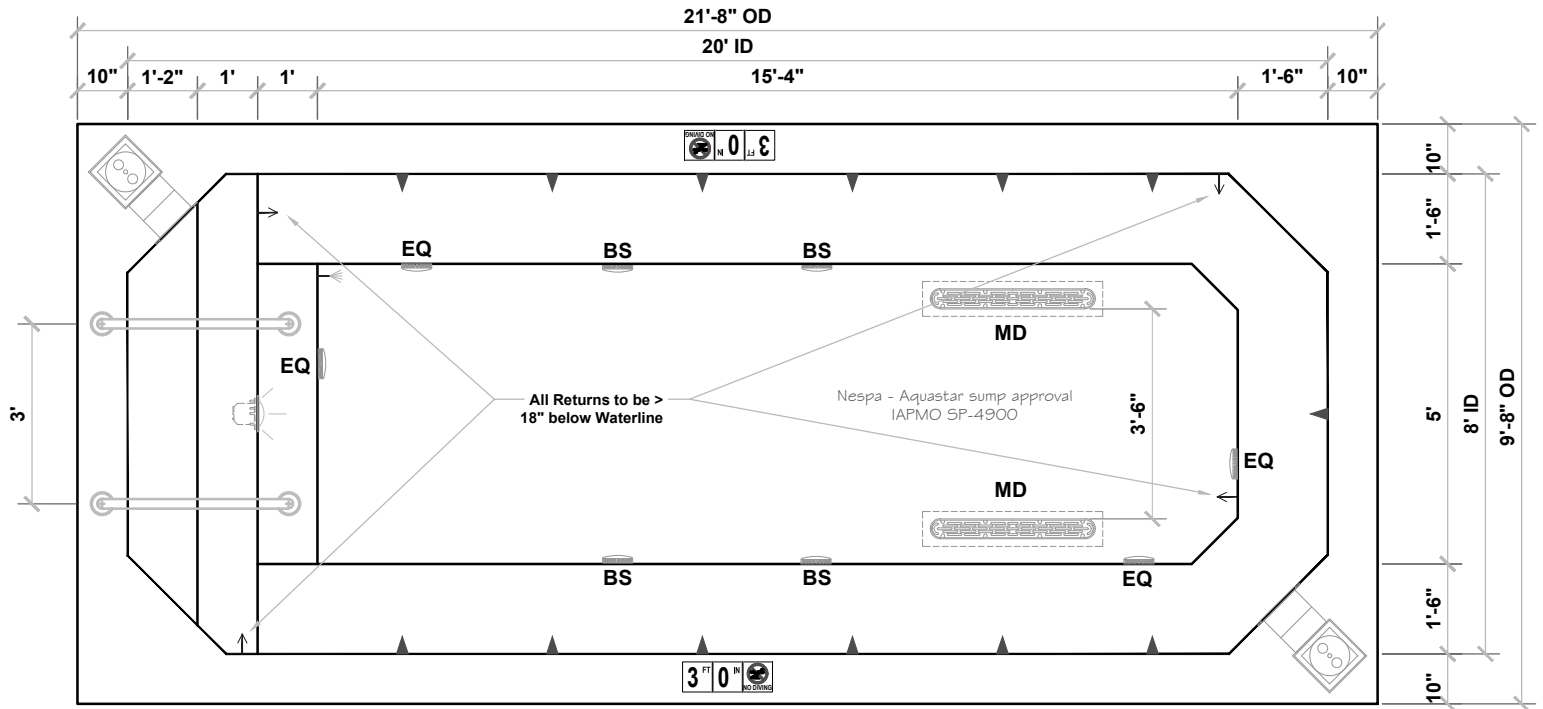

# Legacy 8' x 20' DSA

SPECIFICATIONS	
SHELL WEIGHT:	5600 LBS.
WATER WEIGHT:	22072 LBS.
TOTAL SHELL & WATER WEIGHT:	27672.2 LBS.
WATER VOLUME:	353 Cu.Ft.
WATER GALLONS:	2648 GAL.
SURFACE AREA:	154.6 SQ. FT.
SPA LENGTH:	20'-0"
SPA WIDTH:	8'-0"
SPA DEPTH:	3'-6"
PEOPLE:	15
ICC ES LISTING #	PMG-1161
USPC LISTING #	SP14385

## LEGEND:

	SKIMMER	2
	MAIN DRAIN	2
	EQUALIZER	4
	B SUCTION	4
	JET	14
	RETURN	4
	WATER FILL	1
	STILLING	-
	VAC	-
	LIGHT	1
WATERPROOF SKID SUPPORT STRUCTURE ATTACHED TO SPA AT NESPA FACTORY *SKIDS SUPPLIED BY NESPA		

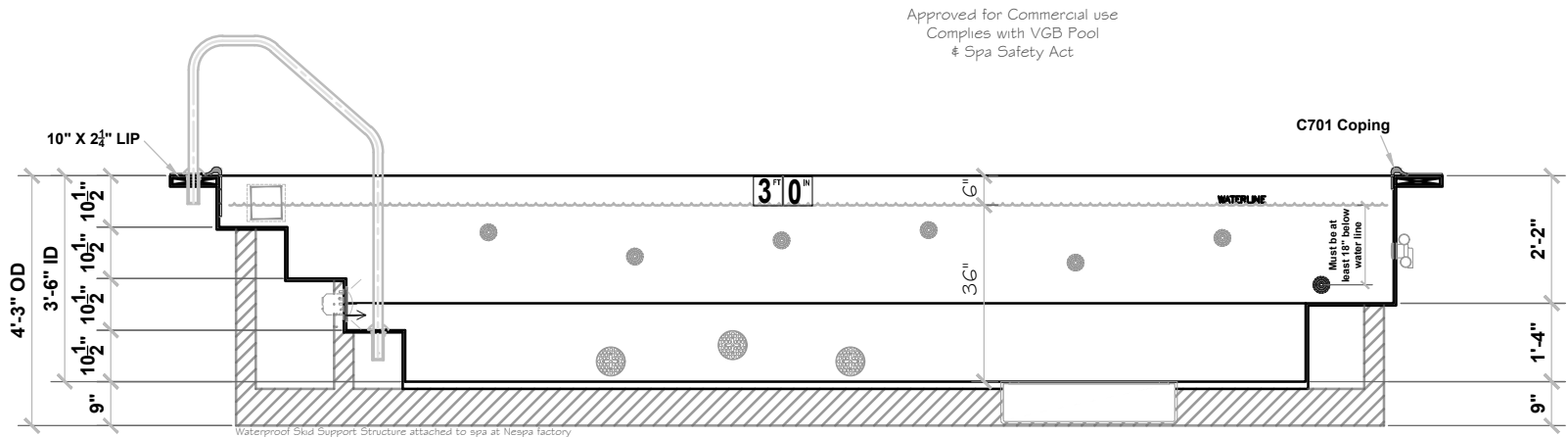
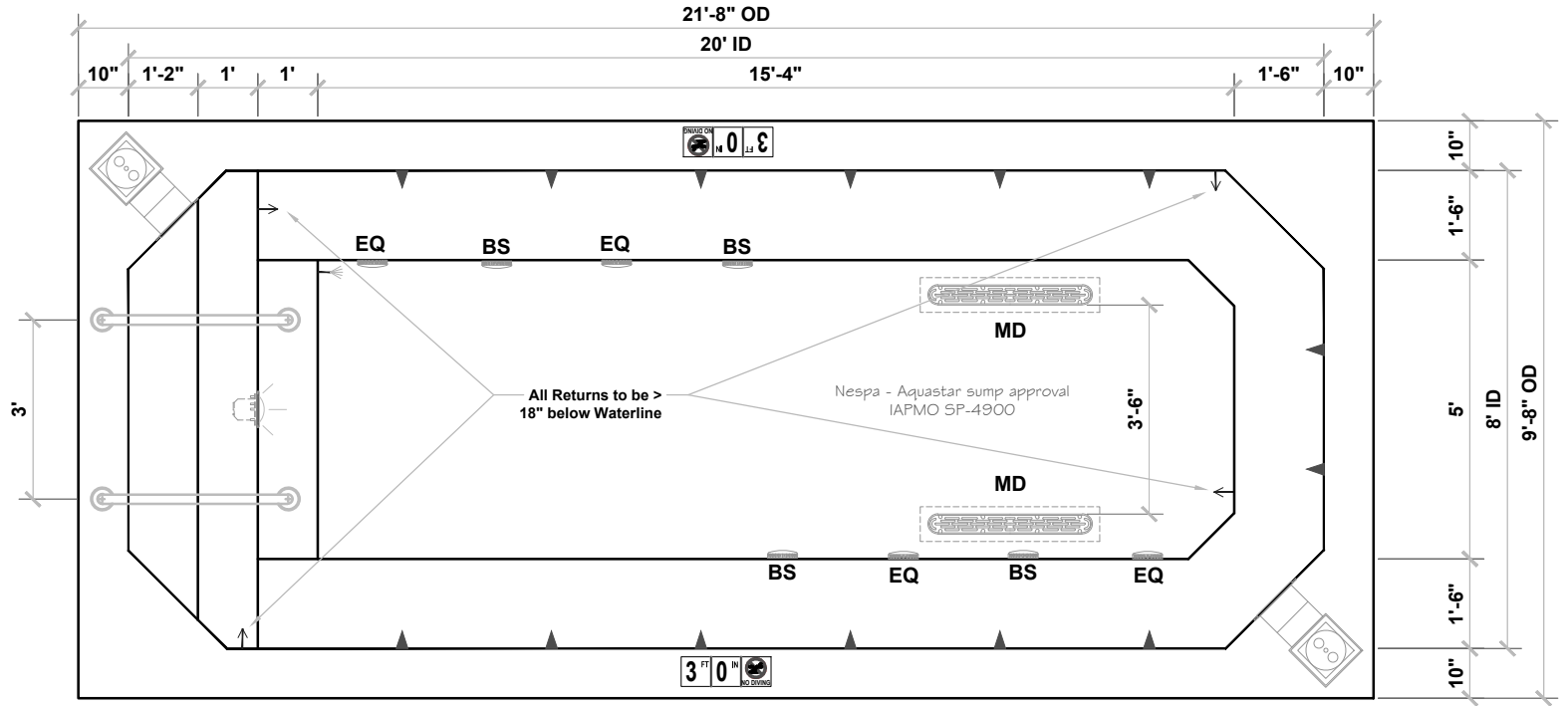

# Legacy 10' x 20' DS MDL# 7108-LA

SPECIFICATIONS	
SHELL WEIGHT:	6200 LBS.
WATER WEIGHT:	28387 LBS.
TOTAL SHELL & WATER WEIGHT:	34587.5 LBS.
WATER VOLUME:	454 Cu.Ft.
WATER GALLONS:	3405 GAL.
SURFACE AREA:	194.5 SQ. FT.
SPA LENGTH:	20'-0"
SPA WIDTH:	10'-0"
SPA DEPTH:	3'-6"
PEOPLE:	19
ICC ES LISTING #	PMG-1161
USPC LISTING #	SP14385

**LEGEND:**

	SKIMMER	2
	MAIN DRAIN	2
	EQUALIZER	4
	B SUCTION	2
	JET	13
	RETURN	4
	WATER FILL	1
	STILLING	-
	VAC	-
	LIGHT	1

WATERPROOF SKID SUPPORT STRUCTURE ATTACHED TO SPA AT NESPA FACTORY

\*SKIDS SUPPLIED BY NESPA

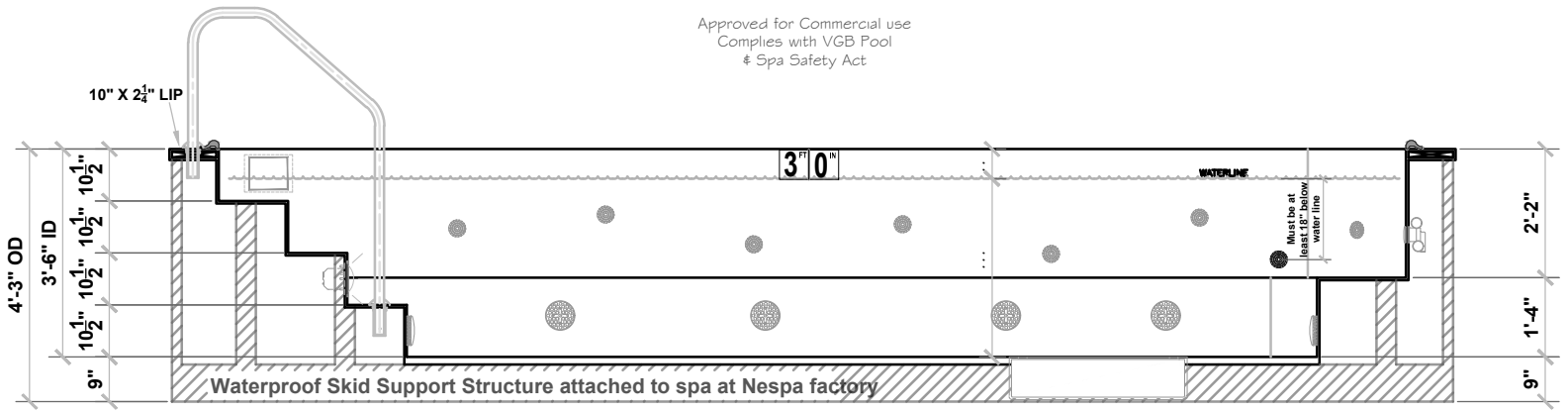
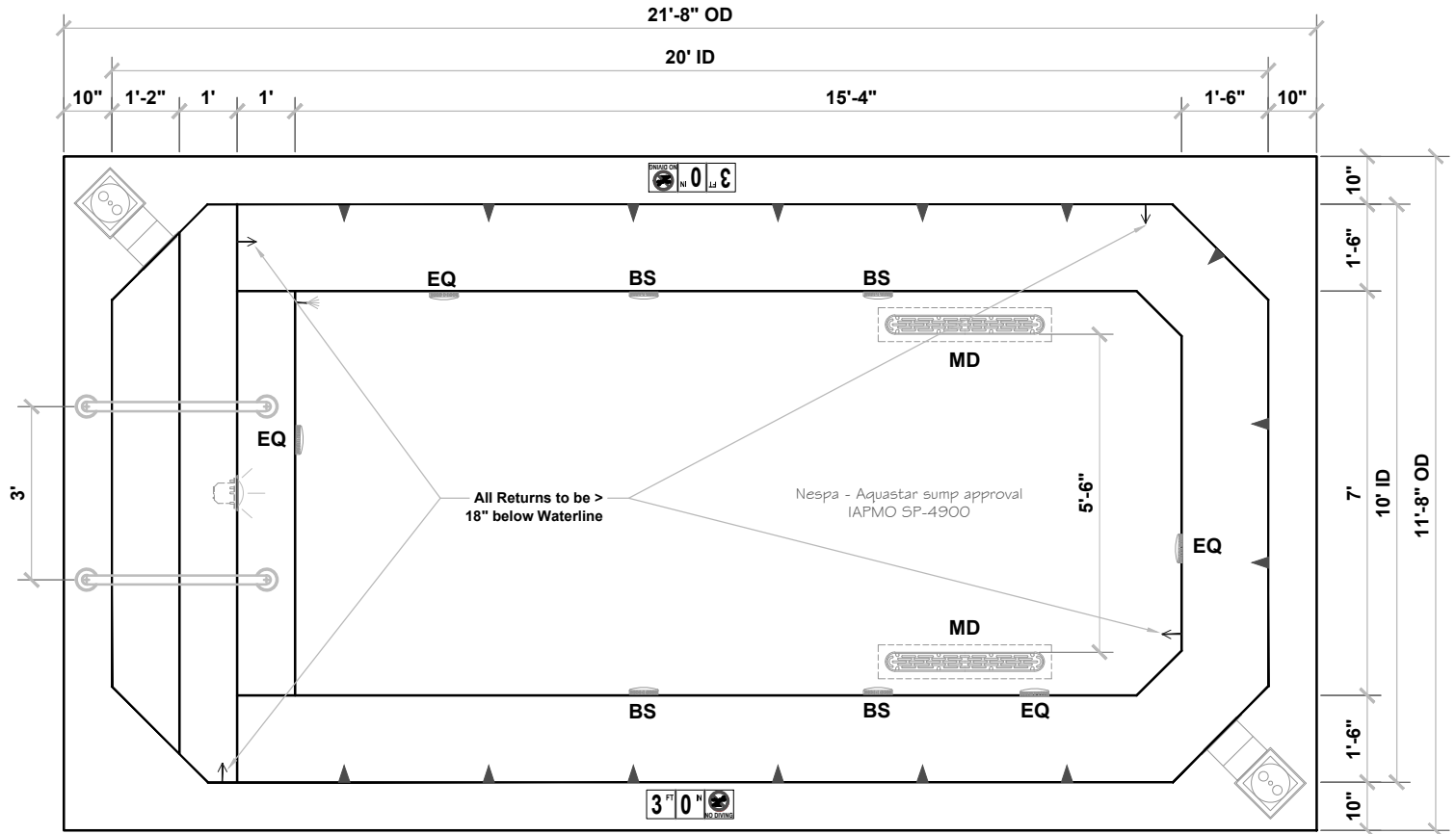

# Legacy 10' x 22' DS MDL# 7109-LA

SPECIFICATIONS	
SHELL WEIGHT:	7000 LBS.
WATER WEIGHT:	31264 LBS.
TOTAL SHELL & WATER WEIGHT:	38263.8 LBS.
WATER VOLUME:	500 Cu.Ft.
WATER GALLONS:	3750 GAL.
SURFACE AREA:	214.5 SQ. FT.
SPA LENGTH:	22'-0"
SPA WIDTH:	10'-0"
SPA DEPTH:	3'-6"
PEOPLE:	21
ICC ES LISTING #:	PMG-1161
USPC LISTING #:	SP14385

### LEGEND:

	SKIMMER	2
	MAIN DRAIN	2
	EQUALIZER	4
	B SUCTION	2
	JET	13
	RETURN	4
	WATER FILL	1
	STILLING	-
	VAC	-
	LIGHT	1

WATERPROOF SKID SUPPORT STRUCTURE ATTACHED TO SPA AT NESPA FACTORY

\*SKIDS SUPPLIED BY NESPA

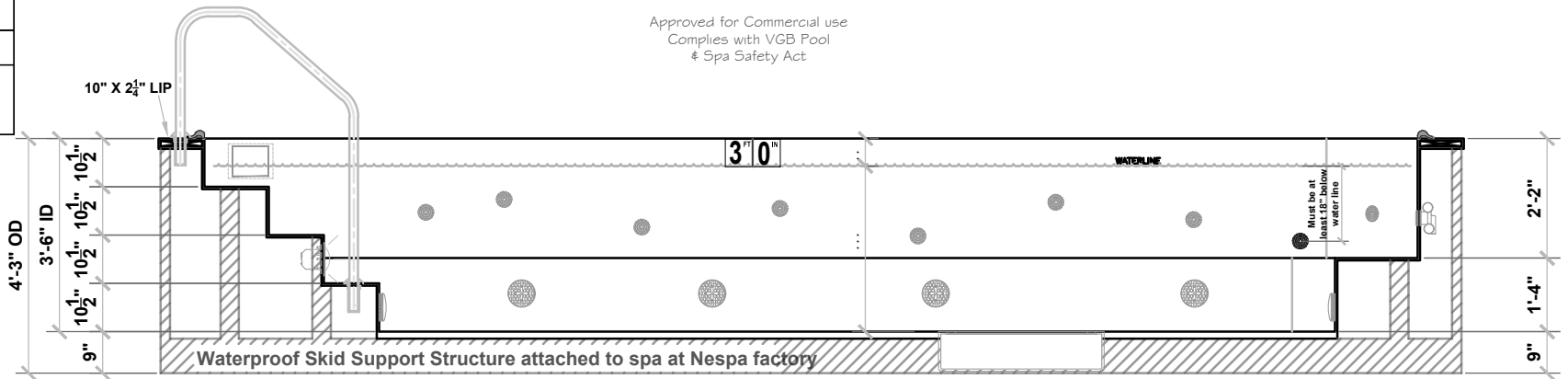
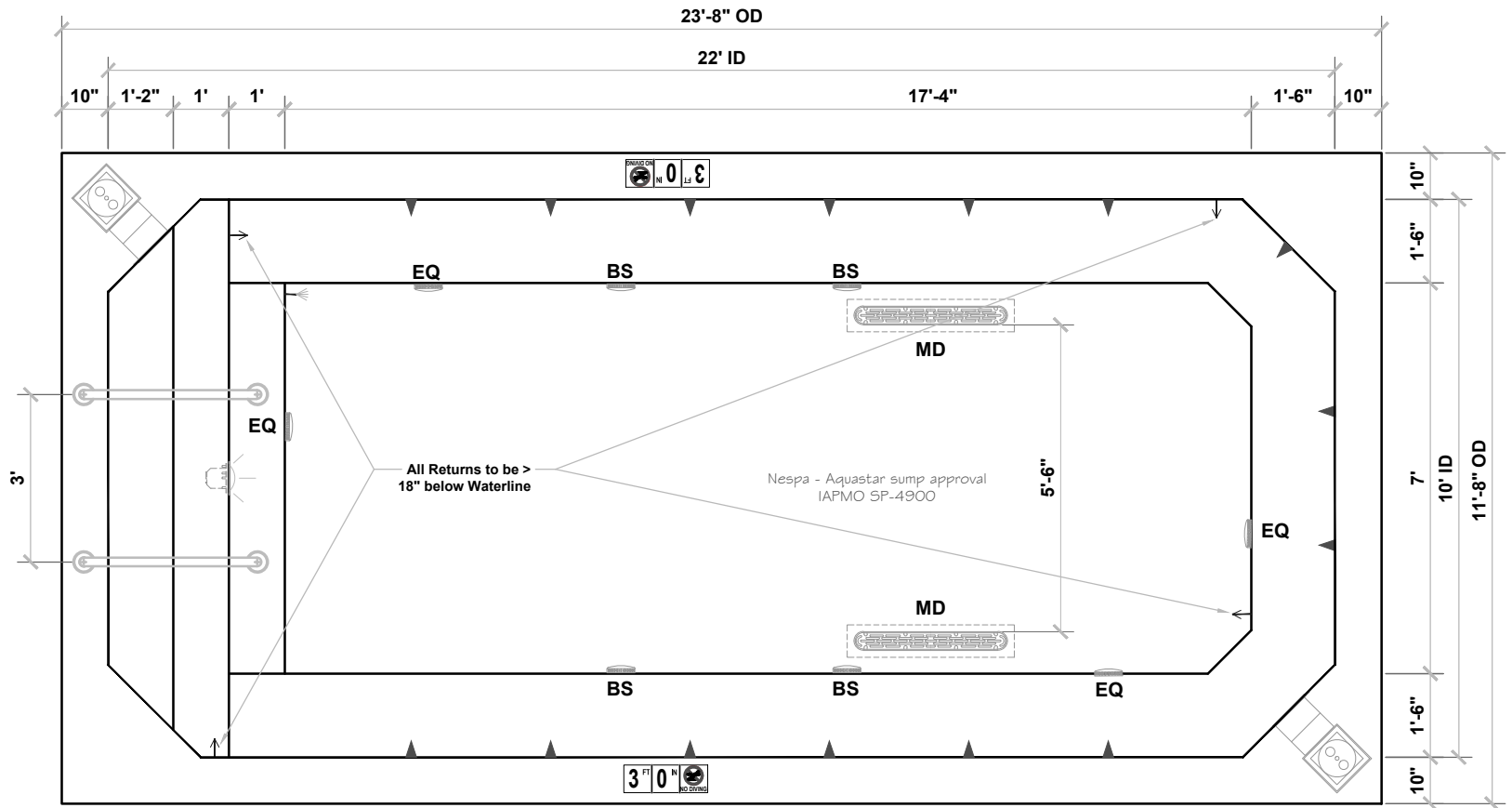



# LEGACY CS 46 8' X 10'

## MDL# 7802 LA

SPECIFICATIONS	
SHELL WEIGHT:	2500 LBS.
WATER WEIGHT:	10942 LBS.
TOTAL SHELL & WATER WEIGHT:	13442.3 LBS.
WATER VOLUME:	175 Cu.Ft.
WATER GALLONS:	1313 GAL.
SURFACE AREA:	79.0 SQ. FT.
SPA LENGTH:	10'-0"
SPA WIDTH:	8'-0"
SPA DEPTH	3'-6"
PEOPLE	7
ICC ES LISTING #	PMG-1161
USPC LISTING #	SP14385

### LEGEND:

	SKIMMER	1
	MAIN DRAIN	2
	EQUALIZER	2
	B SUCTION	2
	JET	11
	RETURN	3
	WATER FILL	1
	STILLING	-
	VAC	-
	LIGHT	1
WATERPROOF SKID SUPPORT STRUCTURE ATTACHED TO SPA AT NESPA FACTORY *SKIDS SUPPLIED BY NESPA		

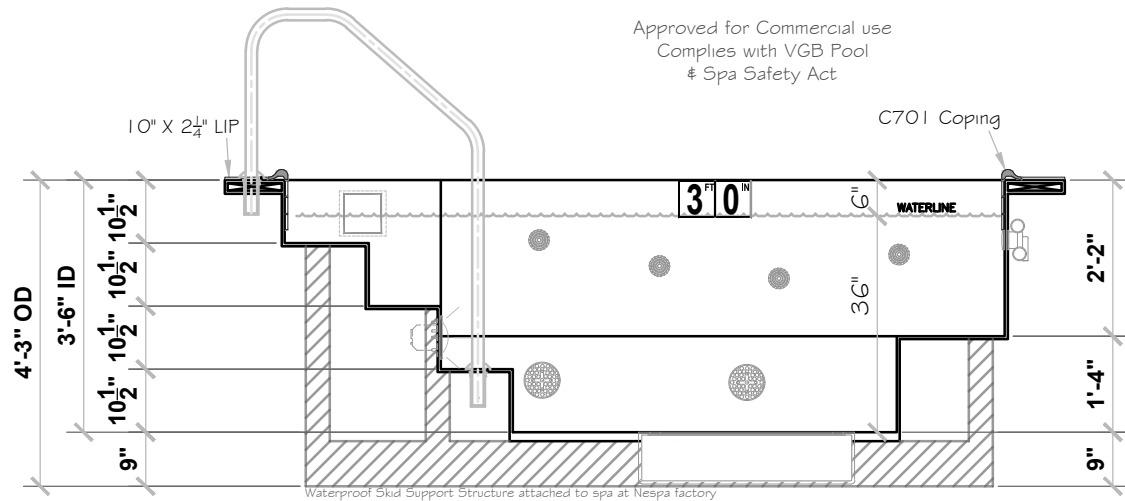
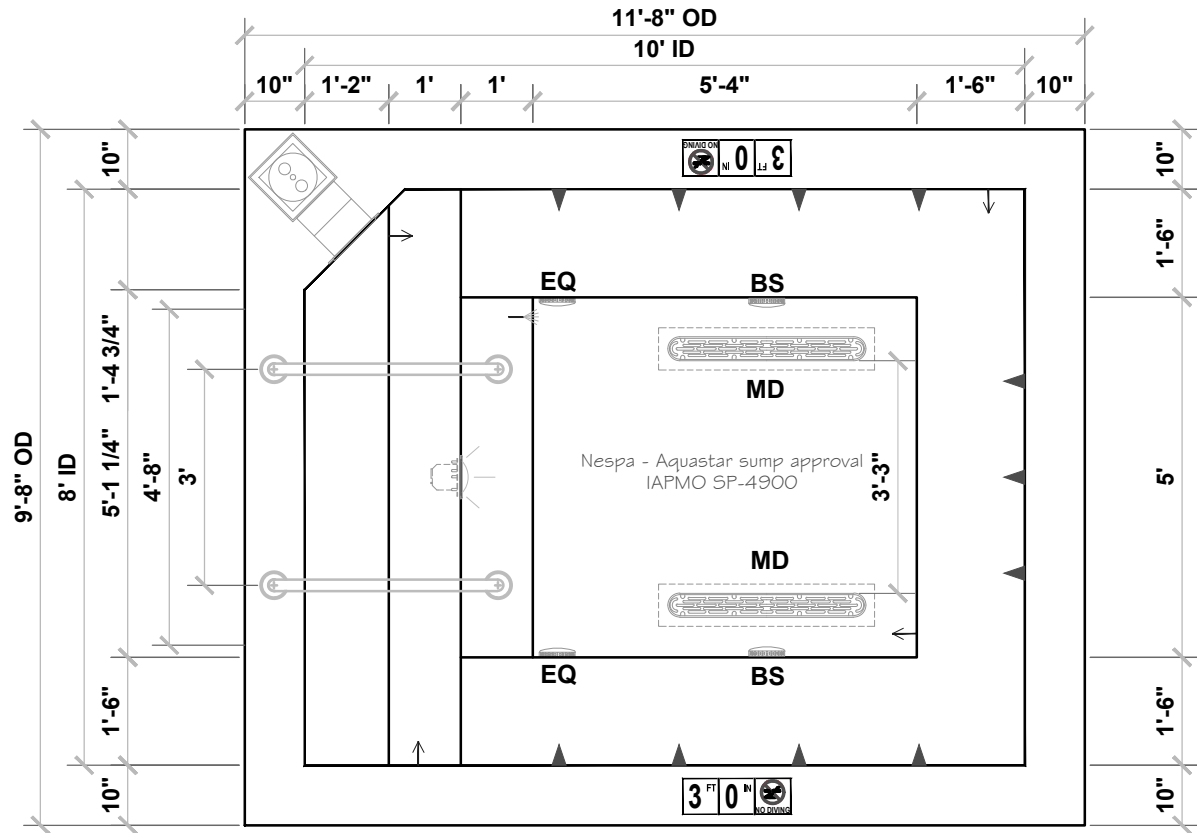

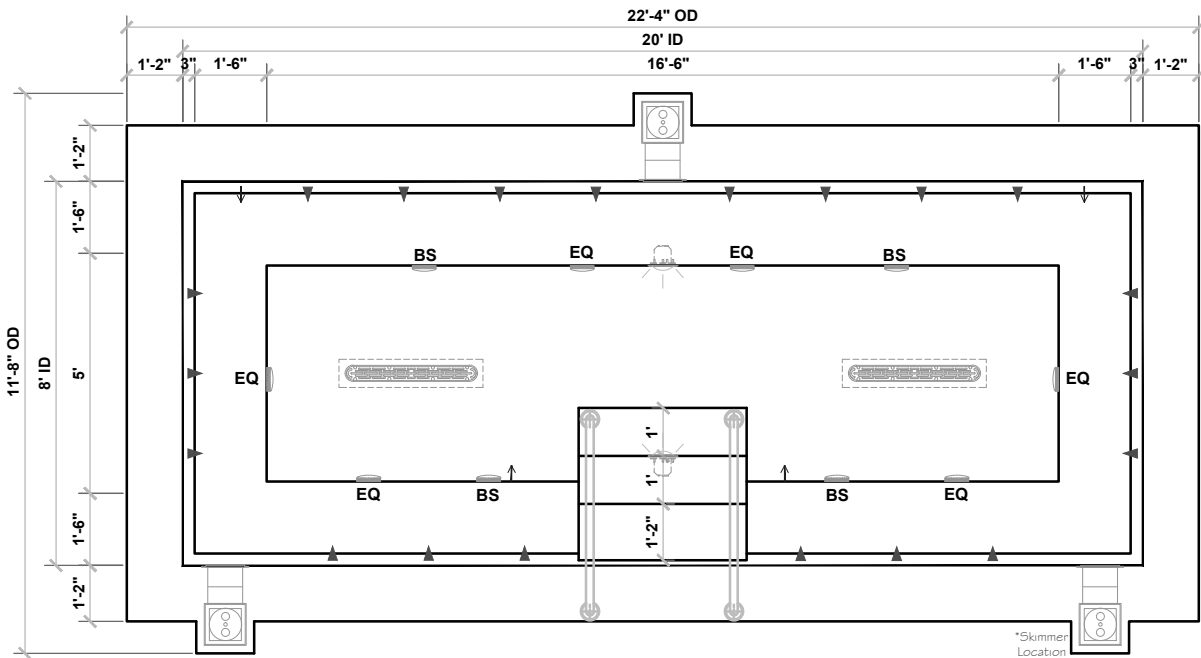

Approved for Commercial use  
Complies with VGB Pool  
& Spa Safety Act

\*Skimmer  
Location  
Optional

## LEGACY M

SPECIFICATIONS	
SHELL WEIGHT:	5000 LBS.
WATER WEIGHT:	26449 LBS.
TOTAL SHELL & WATER WEIGHT:	31449.1 LBS.
WATER VOLUME:	423 Cu.Ft.
WATER GALLONS:	3173 GAL.
SURFACE AREA:	160.0 SQ. FT.
SPA LENGTH:	20'-0"
SPA WIDTH:	8'-0"
SPA DEPTH:	3'-4"
PEOPLE:	15
ICC ES LISTING #	PMG-1161
USPC LISTING #	SP14385

### LEGEND:

	SKIMMER	3
	MAIN DRAIN	2
	EQUALIZER	6
	B SUCTION	2
	JET	22
	RETURN	4
	WATER FILL	1
	STILLING	-
	VAC	-
	LIGHT	2

WATERPROOF SKID SUPPORT  
STRUCTURE ATTACHED TO  
SPA AT NESPA FACTORY

\*SKIDS SUPPLIED BY NESPA

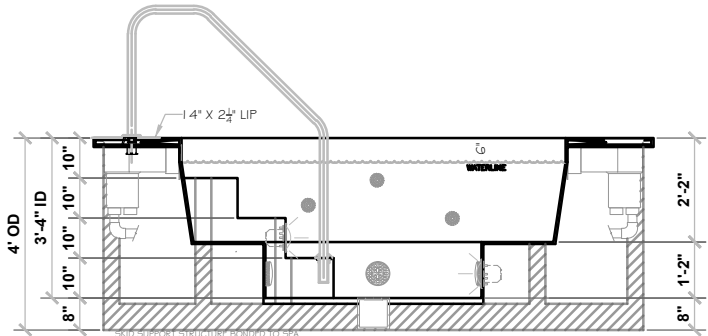
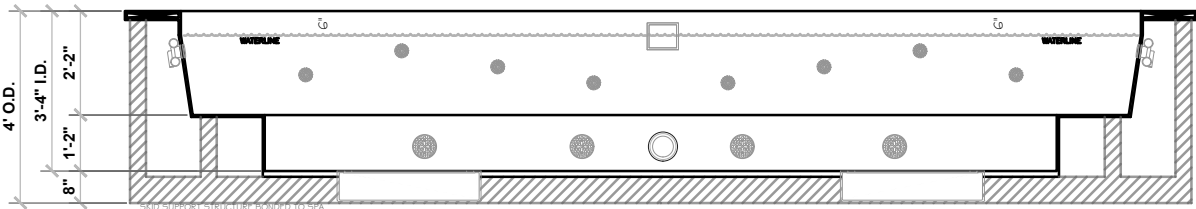

# LEGACY 45

SPECIFICATIONS	
SHELL WEIGHT:	7000 LBS.
WATER WEIGHT:	26574 LBS.
TOTAL SHELL & WATER WEIGHT:	33574.2 LBS.
WATER VOLUME:	425 Cu.Ft.
WATER GALLONS:	3188 GAL.
SURFACE AREA:	139.7 SQ. FT.
SPA LENGTH:	18'-9"
SPA WIDTH:	10'-2"
SPA DEPTH:	3'-6"
PEOPLE:	20
ICC ES LISTING #	PMG-1161
USPC LISTING #	SP14385

## LEGEND:

	SKIMMER	3
	MAIN DRAIN	2
	EQUALIZER	6
	B SUCTION	4
	JET	22
	RETURN	4
	WATER FILL	1
	STILLING	-
	VAC	-
	LIGHT	2

WATERPROOF SKID SUPPORT STRUCTURE ATTACHED TO SPA AT NESPA FACTORY  
\*WIDS SUPPLIED BY NESPA

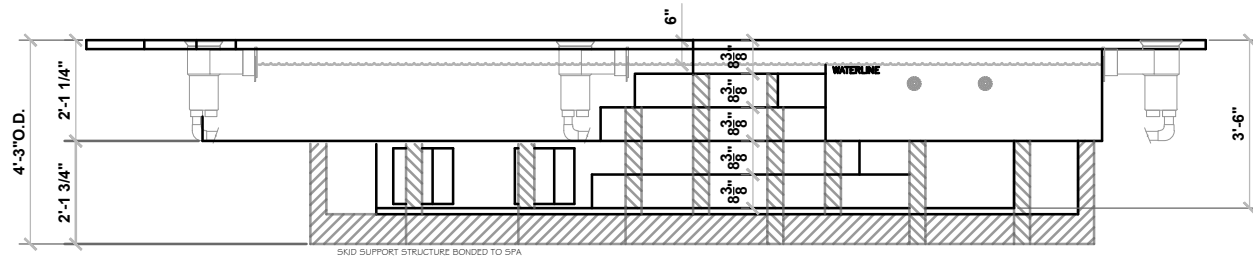
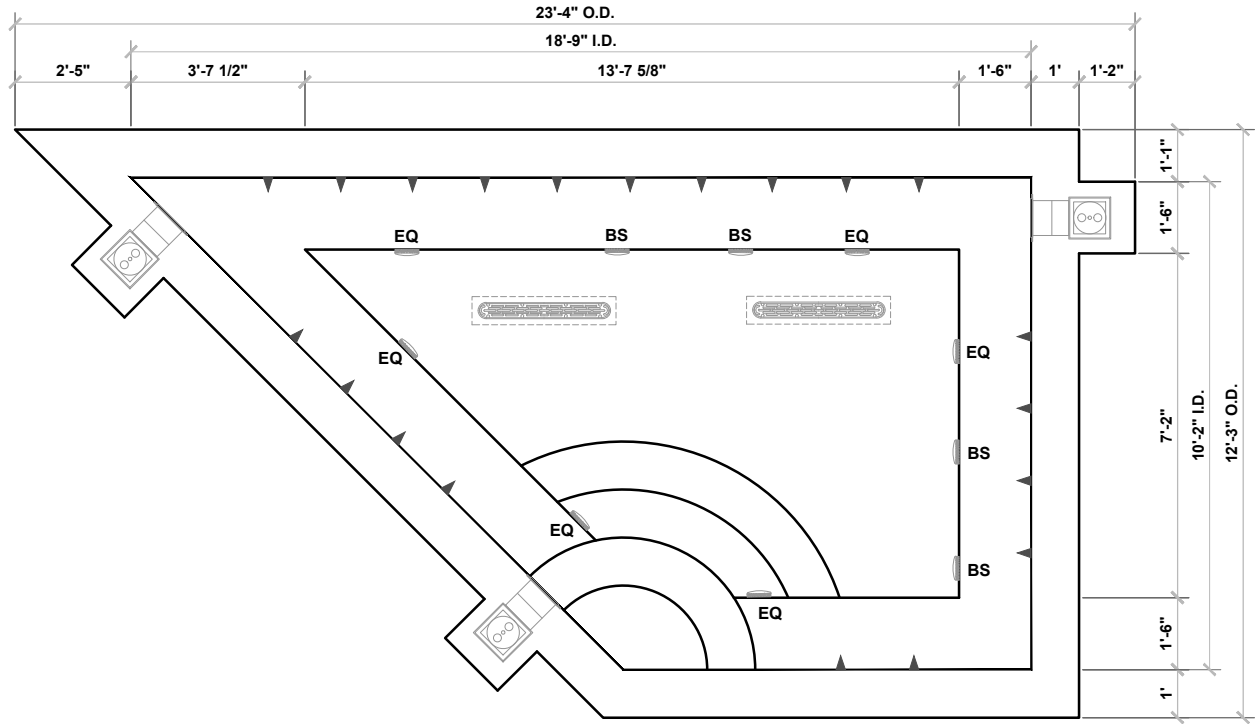

# LEGACY PARA

SPECIFICATIONS	
SHELL WEIGHT:	12850 LBS.
WATER WEIGHT:	36516 LBS.
TOTAL SHELL & WATER WEIGHT:	49366.1 LBS.
WATER VOLUME:	584 Cu Ft.
WATER GALLONS:	4380 GAL.
SURFACE AREA:	200.9 SQ. FT.
SPA LENGTH:	15'-6"
SPA WIDTH:	13'-7"
SPA DEPTH:	3'-6"
PEOPLE:	20
ICC ES LISTING #	PMG-1161
USPC LISTING #	SP14385

## LEGEND:

	SKIMMER	4
	MAIN DRAIN	2
	EQUALIZER	8
	B SUCTION	8
	JET	20
	RETURN	4
	WATER FILL	1
	STILLING	-
	VAC	-
	LIGHT	2

WATERPROOF SKID SUPPORT STRUCTURE ATTACHED TO SPA AT NESPA FACTORY  
 \*SKIDS SUPPLIED BY NESPA

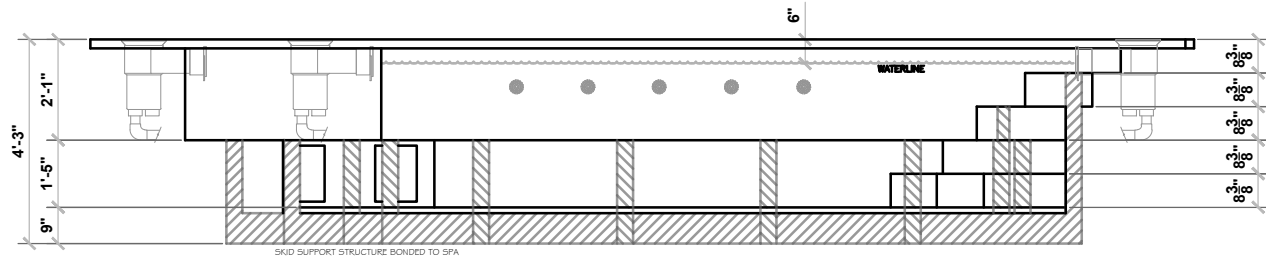
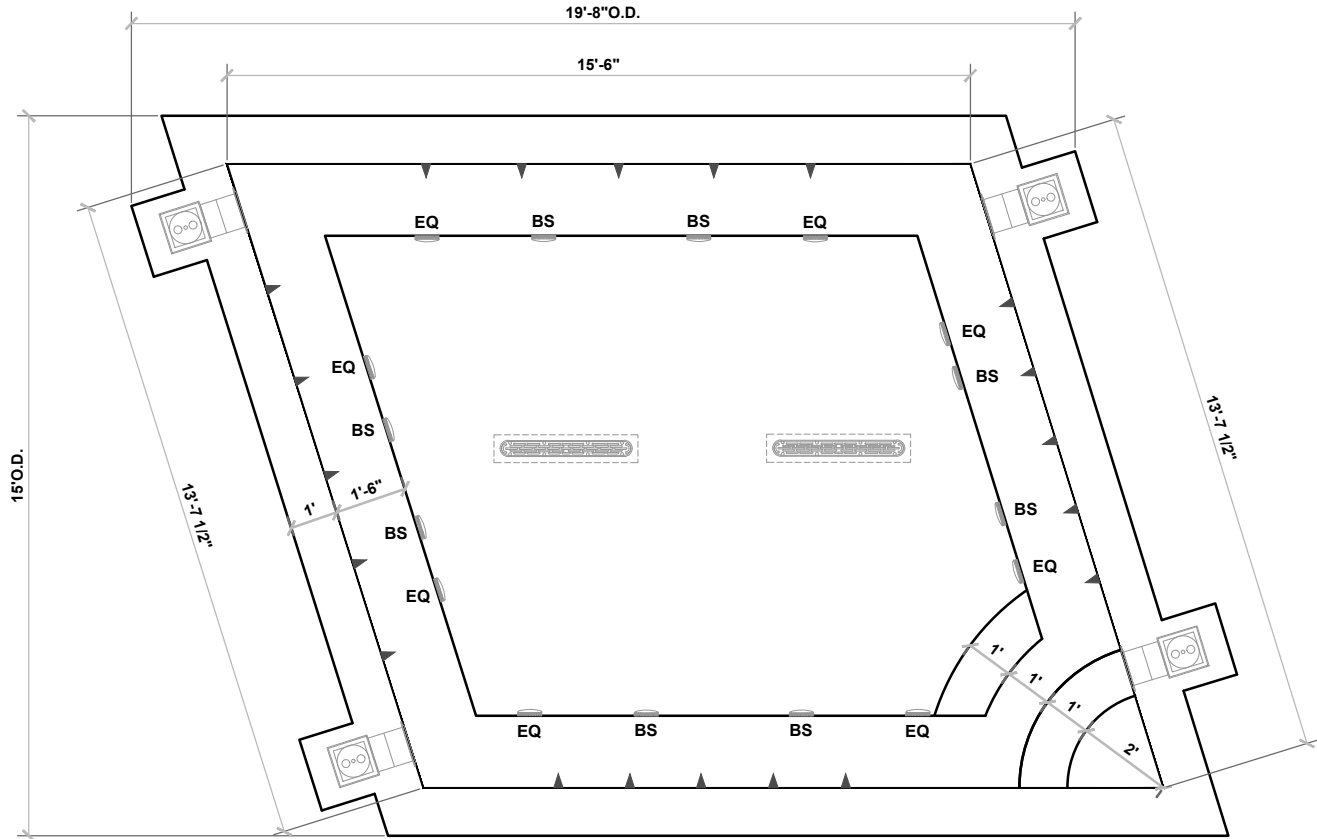













# Maxima

## MDL# 401-LA

SPECIFICATIONS	
SHELL WEIGHT:	1900 LBS.
WATER WEIGHT:	4189 LBS.
TOTAL SHELL & WATER WEIGHT:	6089.3 LBS.
WATER VOLUME:	67 Cu.Ft.
WATER GALLONS:	503 GAL.
SURFACE AREA:	36.5 SQ. FT.
SPA LENGTH:	6'-8"
SPA WIDTH:	6'-8"
SPA DEPTH	3'-9"
PEOPLE	3
ICC ES LISTING #	PMG-1161
USPC LISTING #	SP14385

### LEGEND:

	SKIMMER	1
	MAIN DRAIN	2
	EQUALIZER	2
	B SUCTION	2
	JET	8
	RETURN	3
	WATER FILL	1
	STILLING	-
	VAC	-
	LIGHT	1
WATERPROOF SKID SUPPORT STRUCTURE ATTACHED TO SPA AT NESPA FACTORY   *SKIDS SUPPLIED BY NESPA		

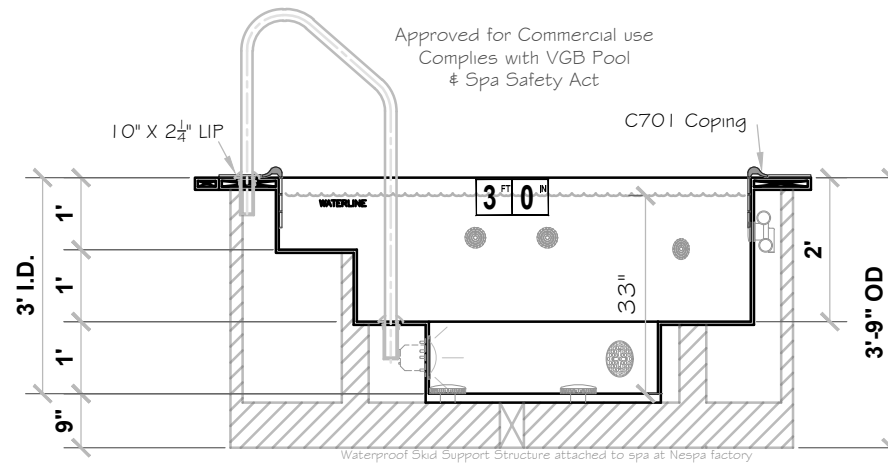
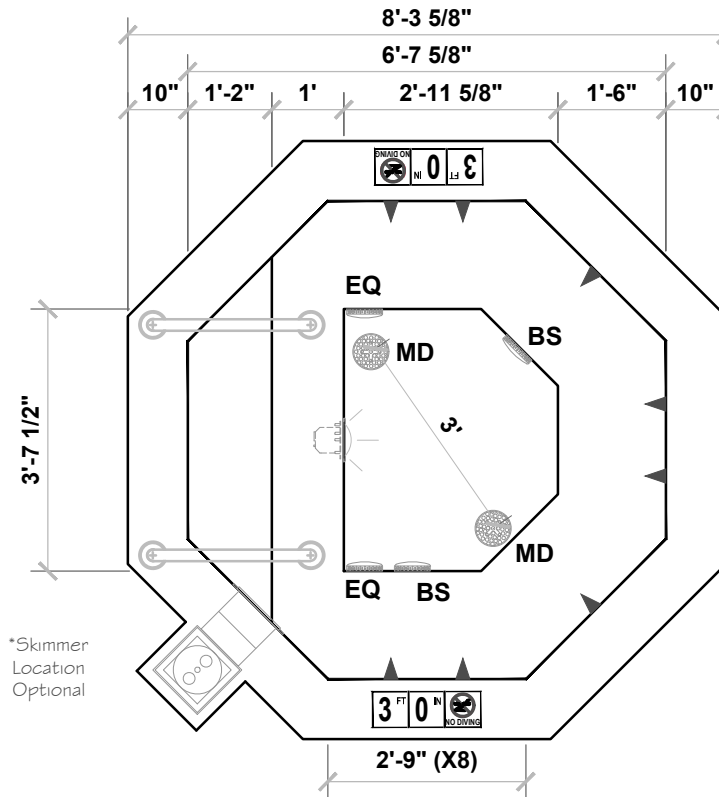

# 9' Mirage

## MDL# 601-LA

SPECIFICATIONS	
SHELL WEIGHT:	2400 LBS.
WATER WEIGHT:	7628 LBS.
TOTAL SHELL & WATER WEIGHT:	10028.4 LBS.
WATER VOLUME:	122 Cu.Ft.
WATER GALLONS:	915 GAL.
SURFACE AREA:	59.5 SQ. FT.
SPA LENGTH:	7'-6"
SPA WIDTH:	9'-0"
SPA DEPTH:	3'-2"
PEOPLE:	5
ICC ES LISTING #	PMG-1161
USPC LISTING #	SP14385

### LEGEND:

	SKIMMER	1
	MAIN DRAIN	2
	EQUALIZER	2
	B SUCTION	2
	JET	7
	RETURN	3
	WATER FILL	1
	STILLING	-
	VAC	-
	LIGHT	1

WATERPROOF SKID SUPPORT STRUCTURE ATTACHED TO SPA AT NESPA FACTORY

\*SKIDS SUPPLIED BY NESPA

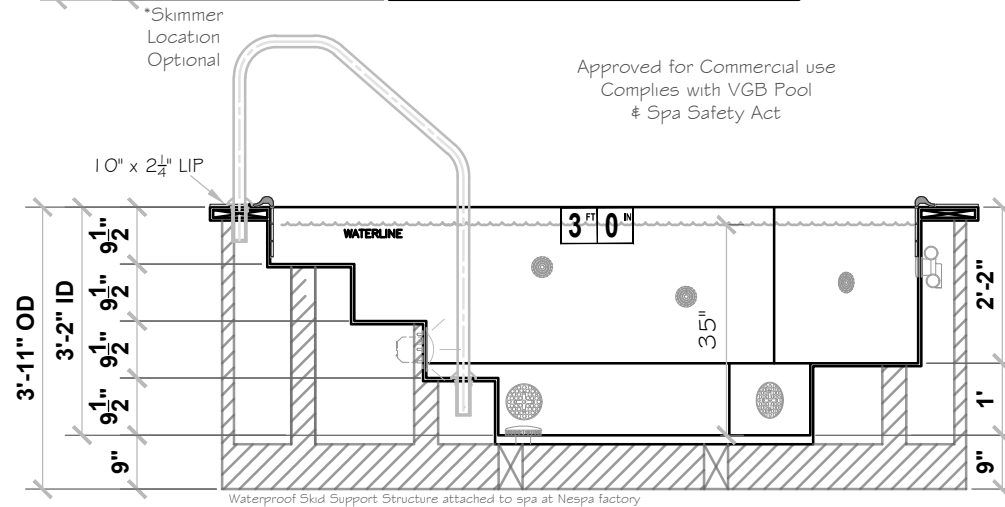
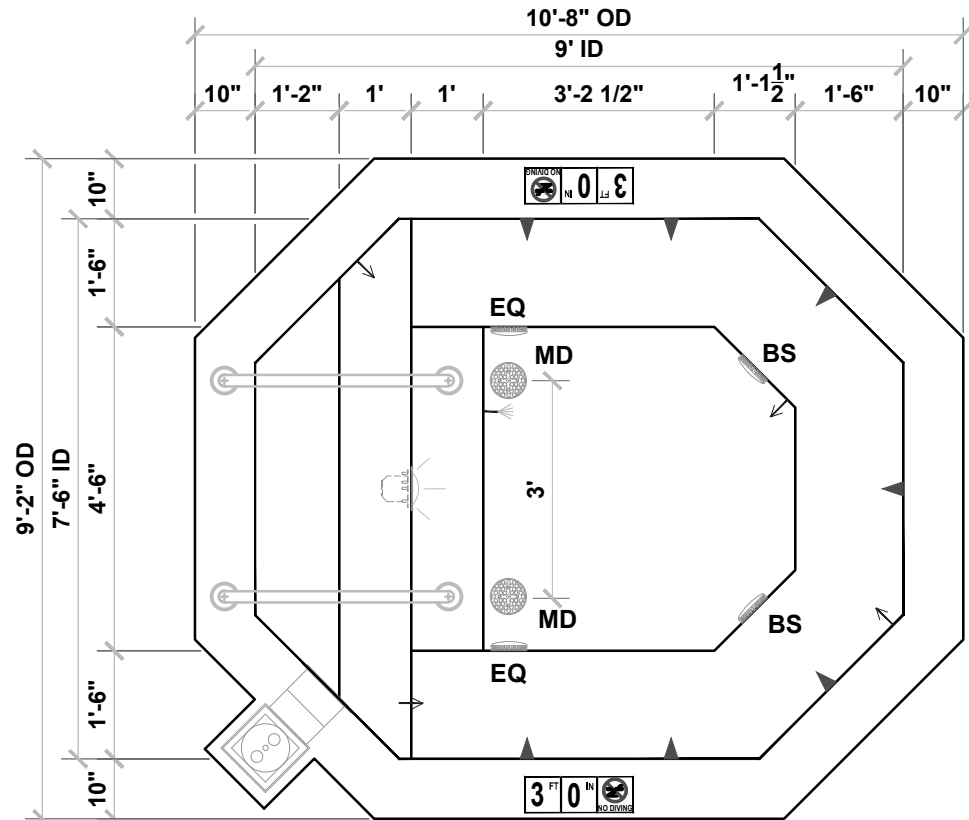





# 11' Mirage MDL# 602-LA

## SPECIFICATIONS

SHELL WEIGHT:	2650 LBS.
WATER WEIGHT:	10342 LBS.
TOTAL SHELL & WATER WEIGHT:	12992 LBS.
WATER VOLUME:	165.4 Cu.Ft.
WATER GALLONS:	1241 GAL.
SURFACE AREA:	74.5 SQ. FT.
SPA LENGTH:	11'-0"
SPA WIDTH:	7'-6"
SPA DEPTH:	3'-4"
PEOPLE	7
ICC ES LISTING #	PMG-1161
USPC LISTING #	SP14385

## LEGEND:

	SKIMMER	1
	MAIN DRAIN	2
	EQUALIZER	2
	B SUCTION	4
	JET	9
	RETURN	3
	WATER FILL	1
	STILLING	-
	VAC	-
	LIGHT	1
WATERPROOF SKID SUPPORT STRUCTURE ATTACHED TO SPA AT NESPA FACTORY  *SKIDS SUPPLIED BY NESPA		

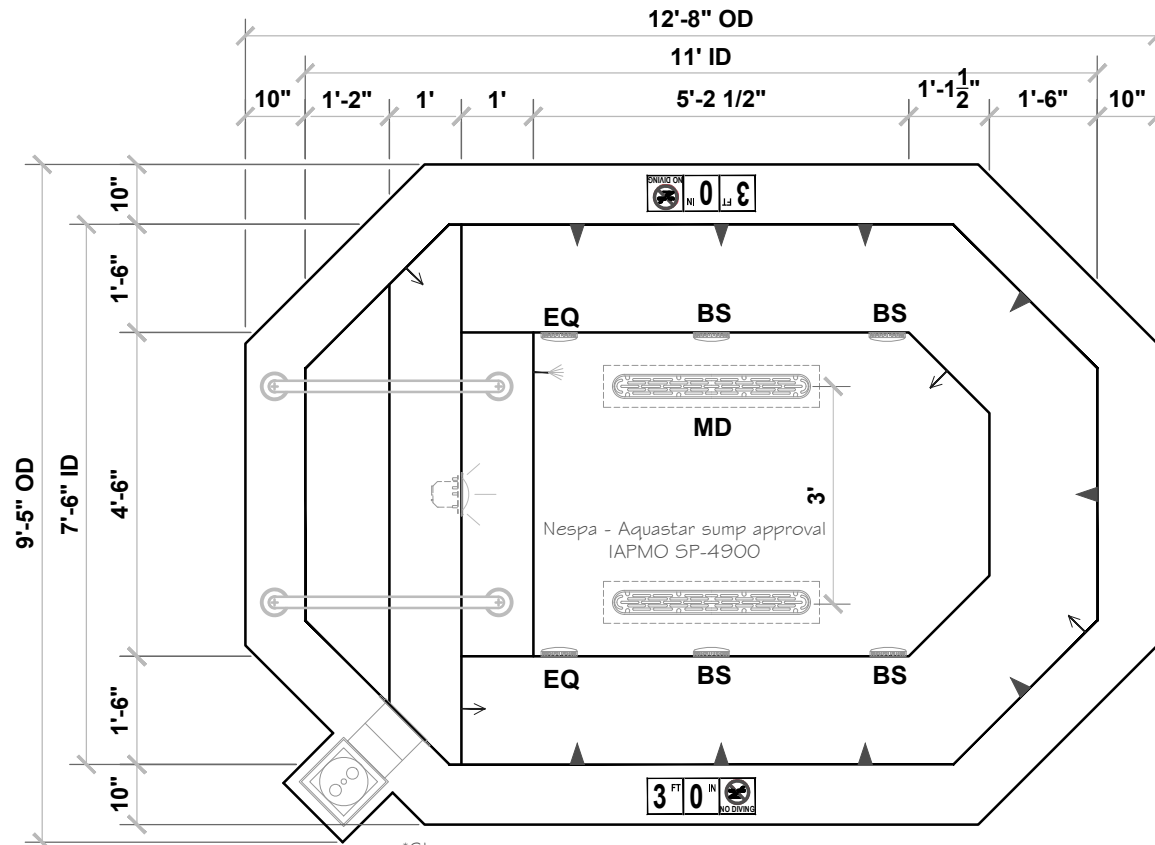

\*Skimmer Location Optional

Approved for Commercial use  
Complies with VGB Pool  
# Spa Safety Act

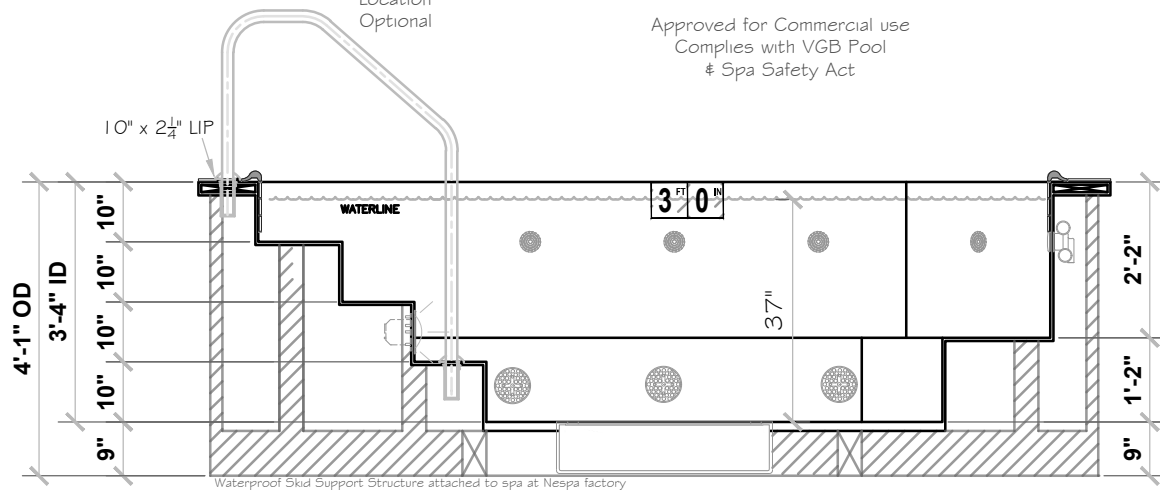

# 13' Mirage MDL# 603-LA

SPECIFICATIONS	
SHELL WEIGHT:	2900 LBS.
WATER WEIGHT:	13256 LBS.
TOTAL SHELL & WATER WEIGHT:	16155.8 LBS.
WATER VOLUME:	212 Cu.Ft.
WATER GALLONS:	1590 GAL.
SURFACE AREA:	89.5 SQ. FT.
SPA LENGTH:	13'-0"
SPA WIDTH:	7'-6"
SPA DEPTH:	3'-6"
PEOPLE:	8
ICC ES LISTING #	PMG-1161
USPC LISTING #	SP14385

### LEGEND:

	SKIMMER	2
	MAIN DRAIN	2
	EQUALIZER	4
	B SUCTION	4
	JET	11
	RETURN	4
	WATER FILL	1
	STILLING	-
	VAC	-
	LIGHT	1
WATERPROOF SKID SUPPORT STRUCTURE ATTACHED TO SPA AT NESPA FACTORY *SKIDS SUPPLIED BY NESPA		

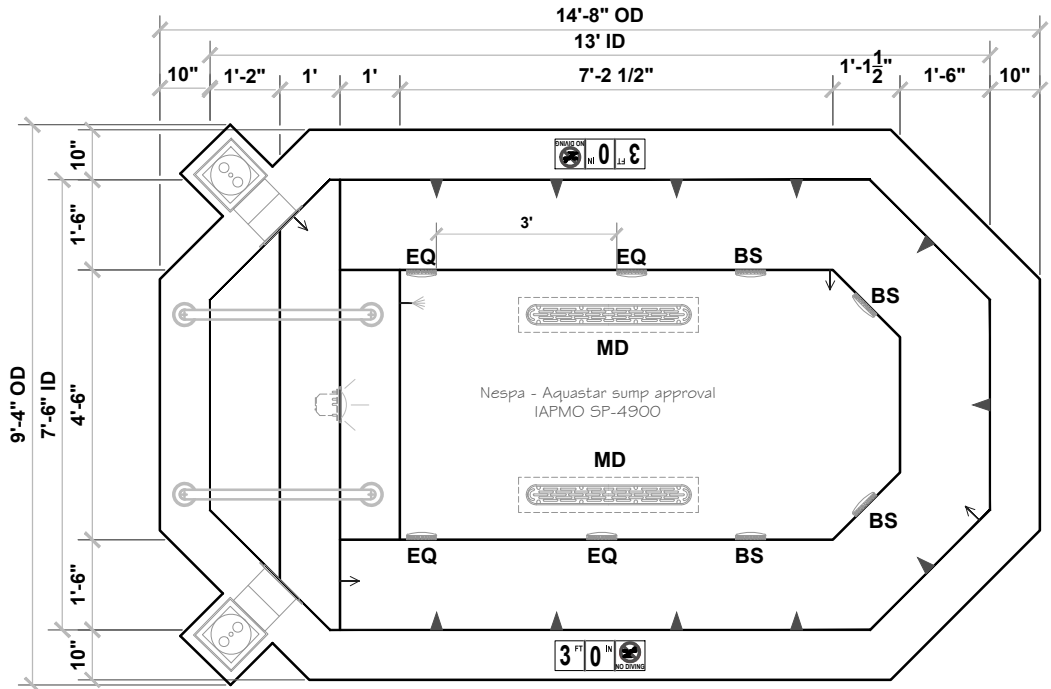

Approved for Commercial use  
Complies with VGB Pool  
& Spa Safety Act

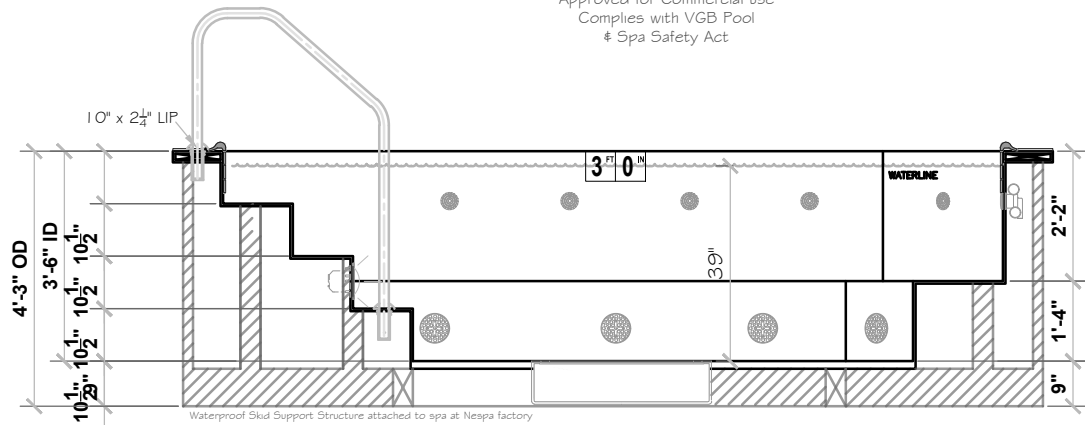



# 15' Mirage MDL# 604-LA

SPECIFICATIONS	
SHELL WEIGHT:	3150 LBS.
WATER WEIGHT:	15819 LBS.
TOTAL SHELL & WATER WEIGHT:	18969.5 LBS.
WATER VOLUME:	253 Cu.Ft.
WATER GALLONS:	1898 GAL.
SURFACE AREA:	104.5 SQ. FT.
SPA LENGTH:	15'-0"
SPA WIDTH:	7'-6"
SPA DEPTH:	3'-6"
PEOPLE:	10
ICC ES LISTING #:	PMG-1161
USPC LISTING #:	SP14385

### LEGEND:

	SKIMMER	2
	MAIN DRAIN	2
	EQUALIZER	4
	B SUCTION	4
	JET	13
	RETURN	4
	WATER FILL	1
	STILLING	-
	VAC	-
	LIGHT	1
WATERPROOF SKID SUPPORT STRUCTURE ATTACHED TO SPA AT NESPA FACTORY *SKIDS SUPPLIED BY NESPA		

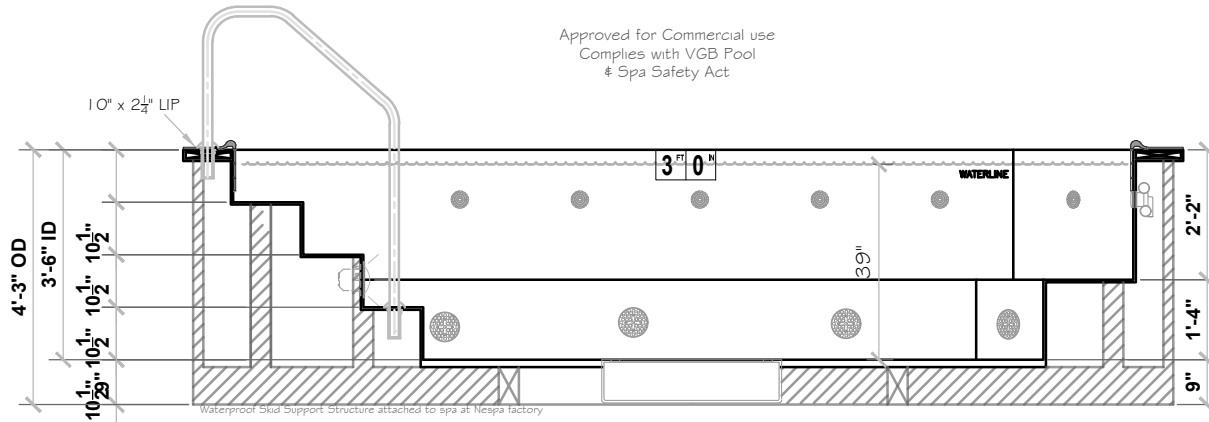
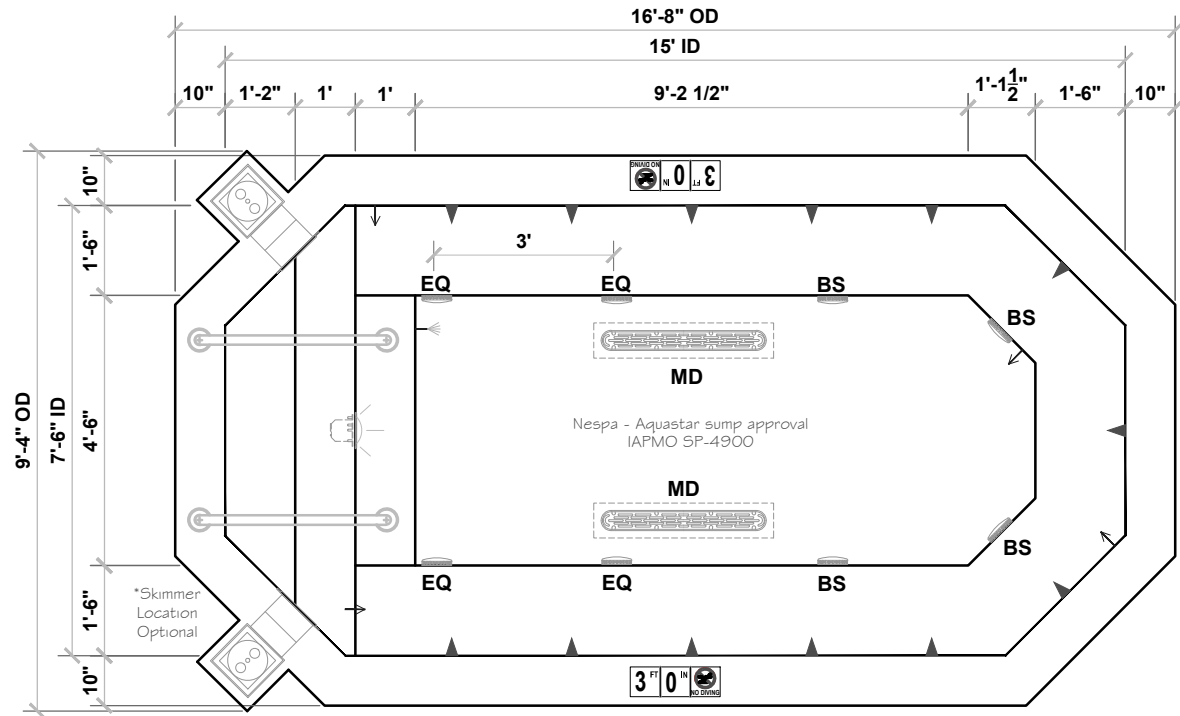

# 17' Mirage MDL# 605-LA

SPECIFICATIONS	
SHELL WEIGHT:	3400 LBS.
WATER WEIGHT:	18358 LBS.
TOTAL SHELL & WATER WEIGHT:	21758.1 LBS.
WATER VOLUME:	293.6 Cu.Ft.
WATER GALLONS:	2202 GAL.
SURFACE AREA:	119.5 SQ. FT.
SPA LENGTH:	17'-0"
SPA WIDTH:	7'-6"
SPA DEPTH	3'-6"
PEOPLE	11
ICC ES LISTING #	PMG-1161
USPC LISTING #	SP14385

## LEGEND:

	SKIMMER	2
	MAIN DRAIN	2
	EQUALIZER	4
	B SUCTION	4
	JET	15
	RETURN	4
	WATER FILL	1
	STILLING	-
	VAC	-
	LIGHT	1
WATERPROOF SKID SUPPORT STRUCTURE ATTACHED TO SPA AT NESPA FACTORY *SKIDS SUPPLIED BY NESPA		

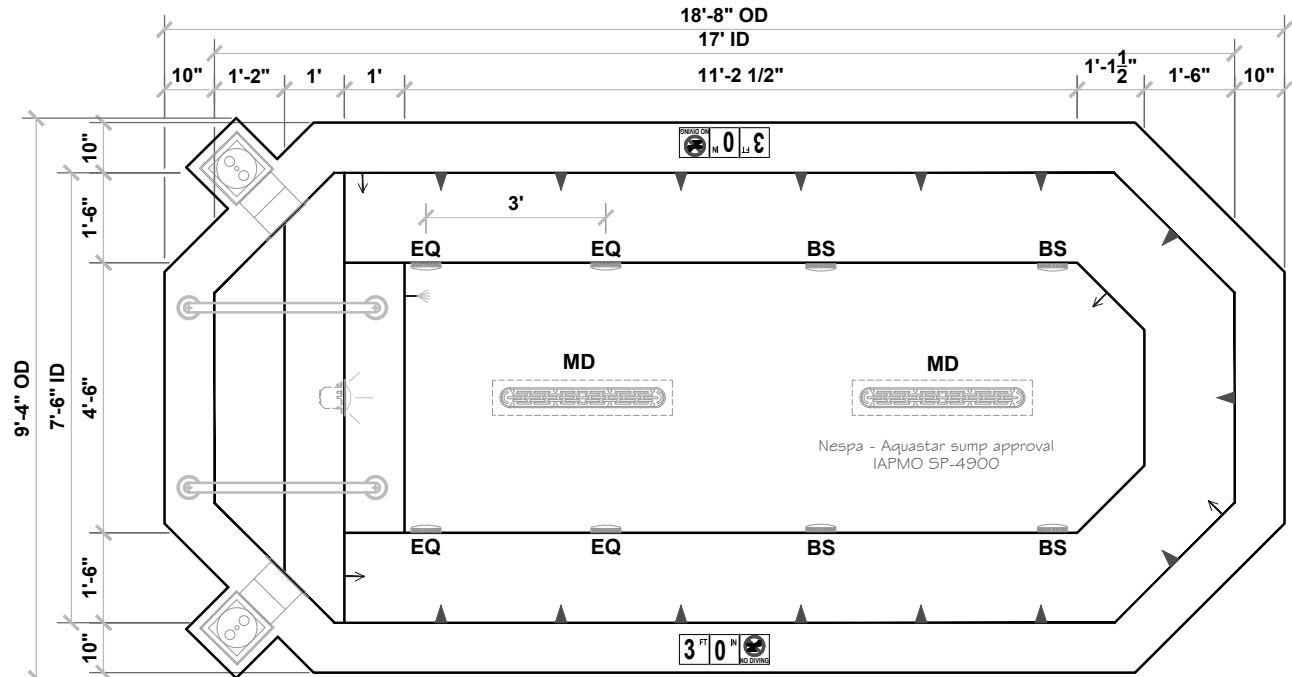

\*Skimmer Location Optional

Approved for Commercial use  
Complies with VGB Pool  
# Spa Safety Act

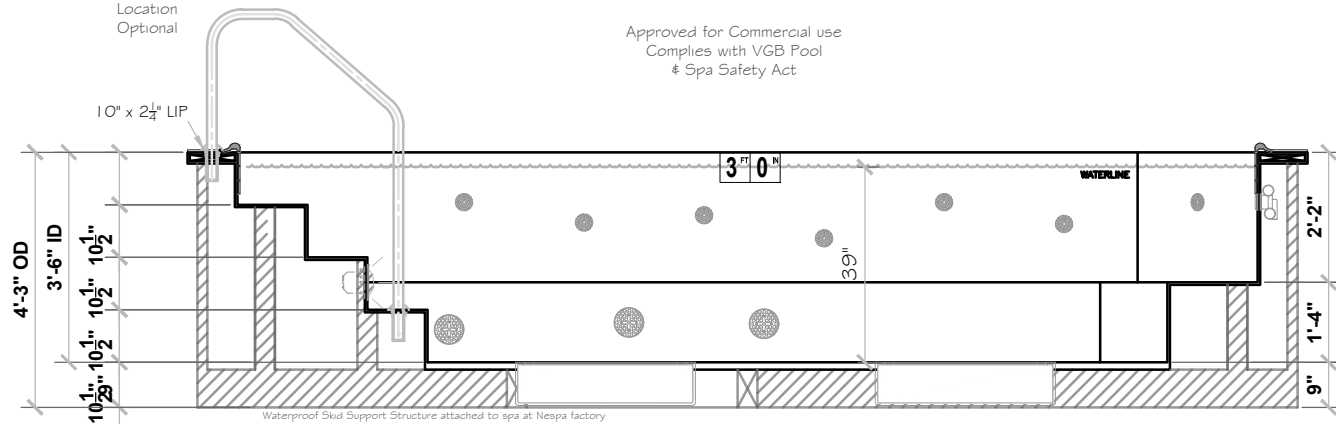

# Rimini

## MDL# 402-LA

SPECIFICATIONS	
SHELL WEIGHT:	1900 LBS.
WATER WEIGHT:	5127 LBS.
TOTAL SHELL & WATER WEIGHT:	7027.3 LBS.
WATER VOLUME:	82 Cu.Ft.
WATER GALLONS:	615 GAL.
SURFACE AREA:	42.6 SQ. FT.
SPA LENGTH:	7'-6"
SPA WIDTH:	6'-9"
SPA DEPTH	3'-2"
PEOPLE	4
ICC ES LISTING #	PMG-1161
USPC LISTING #	SP14385

### LEGEND:

	SKIMMER	1
	MAIN DRAIN	2
	EQUALIZER	2
	B SUCTION	2
	JET	8
	RETURN	3
	WATER FILL	1
	STILLING	-
	VAC	-
	LIGHT	1

WATERPROOF SKID SUPPORT STRUCTURE ATTACHED TO SPA AT NESPA FACTORY



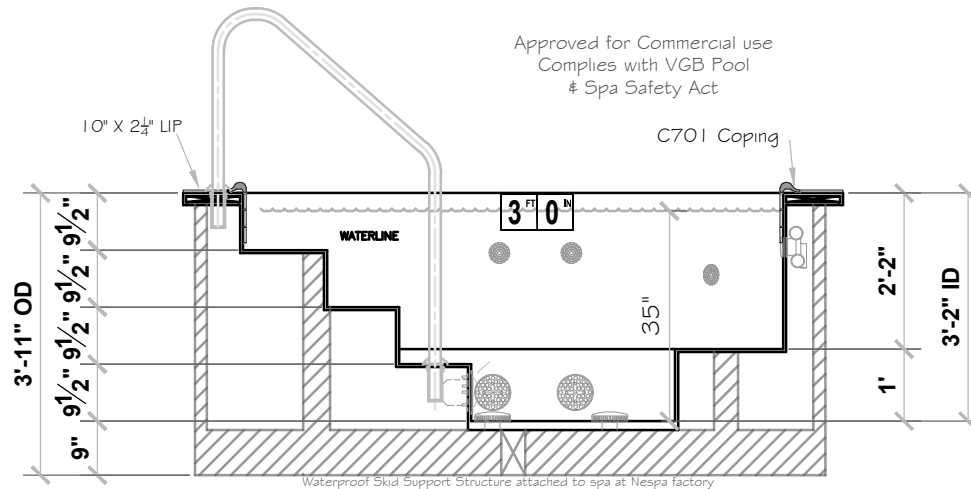
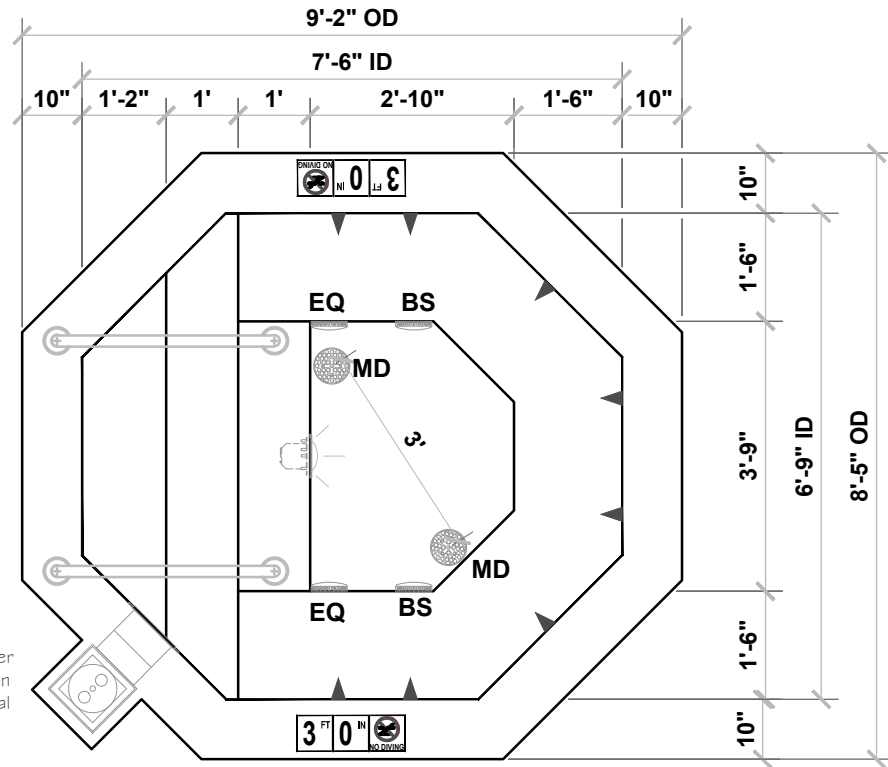







\*SKIDS SUPPLIED BY NESPA



# Rimini Commercial MDL# 403-LA

SPECIFICATIONS	
SHELL WEIGHT:	2300 LBS.
WATER WEIGHT:	7941 LBS.
TOTAL SHELL & WATER WEIGHT:	10241 LBS.
WATER VOLUME:	127 Cu.Ft.
WATER GALLONS:	953 GAL.
SURFACE AREA:	59.9 SQ. FT.
SPA LENGTH:	8'-6"
SPA WIDTH:	8'-6"
SPA DEPTH	3'-4"
PEOPLE	5
ICC ES LISTING #	PMG-1161
USPC LISTING #	SP14385

## LEGEND:

	SKIMMER	1
	MAIN DRAIN	2
	EQUALIZER	2
	B SUCTION	2
	JET	10
	RETURN	3
	WATER FILL	1
	STILLING	-
	VAC	-
	LIGHT	1
<b>WATERPROOF SKID SUPPORT STRUCTURE ATTACHED TO SPA AT NESPA FACTORY</b>		
	*SKIDS SUPPLIED BY NESPA	

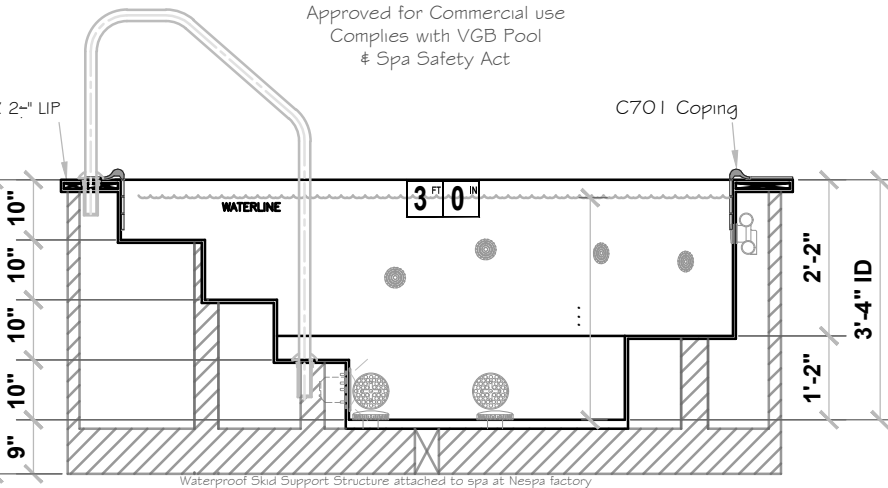
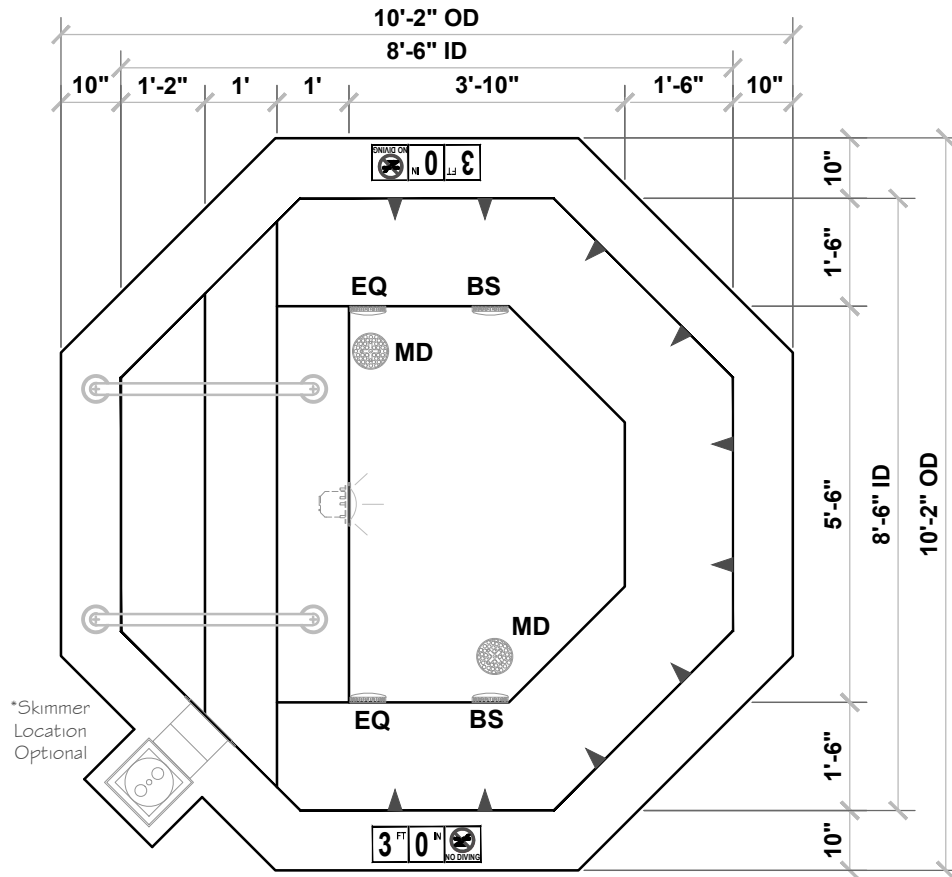













Approved for Commercial use  
Complies with VGB Pool  
& Spa Safety Act



# 6' Round MDL# 501-LA

SPECIFICATIONS	
SHELL WEIGHT:	1700 LBS.
WATER WEIGHT:	3314 LBS.
TOTAL SHELL & WATER WEIGHT:	5014 LBS.
WATER VOLUME:	53 Cu.Ft.
WATER GALLONS:	398 GAL.
SURFACE AREA:	28.3 SQ. FT.
SPA LENGTH:	6'-0"
SPA WIDTH:	6'-0"
SPA DEPTH	3'-0"
PEOPLE	2
ICC ES LISTING #	PMG-1161
USPC LISTING #	SP14385

## LEGEND:

	SKIMMER	1
	MAIN DRAIN	2
	EQUALIZER	2
	B SUCTION	2
	JET	8
	RETURN	3
	WATER FILL	1
	STILLING	-
	VAC	-
	LIGHT	1
WATERPROOF SKID SUPPORT STRUCTURE ATTACHED TO SPA AT NESPA FACTORY   *SKIDS SUPPLIED BY NESPA		

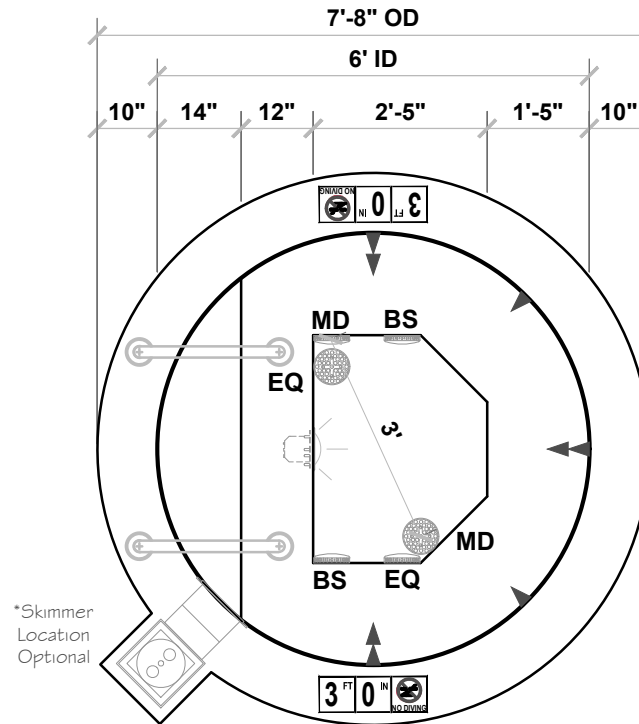



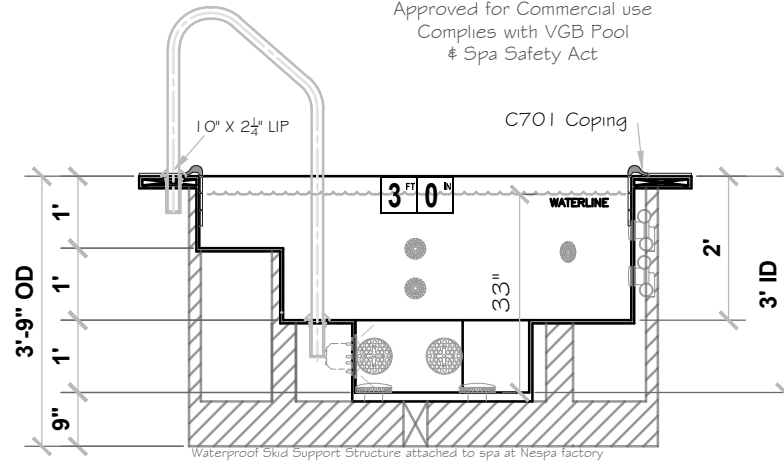









Approved for Commercial use  
Complies with VGB Pool  
# Spa Safety Act



# 6.5' Round MDL# 502-LA

SPECIFICATIONS	
SHELL WEIGHT:	1800 LBS.
WATER WEIGHT:	3877 LBS.
TOTAL SHELL & WATER WEIGHT:	5676.7 LBS.
WATER VOLUME:	62 Cu.Ft.
WATER GALLONS:	465 GAL.
SURFACE AREA:	33.2 SQ. FT.
SPA LENGTH:	6'-6"
SPA WIDTH:	6'-6"
SPA DEPTH:	3'-0"
PEOPLE:	3
ICC ES LISTING #	PMG-1161
USPC LISTING #	SP14385

## LEGEND:

	SKIMMER	1
	MAIN DRAIN	2
	EQUALIZER	2
	B SUCTION	2
	JET	8
	RETURN	3
	WATER FILL	1
	STILLING	-
	VAC	-
	LIGHT	1
WATERPROOF SKID SUPPORT STRUCTURE ATTACHED TO SPA AT NESPA FACTORY   *SKIDS SUPPLIED BY NESPA		

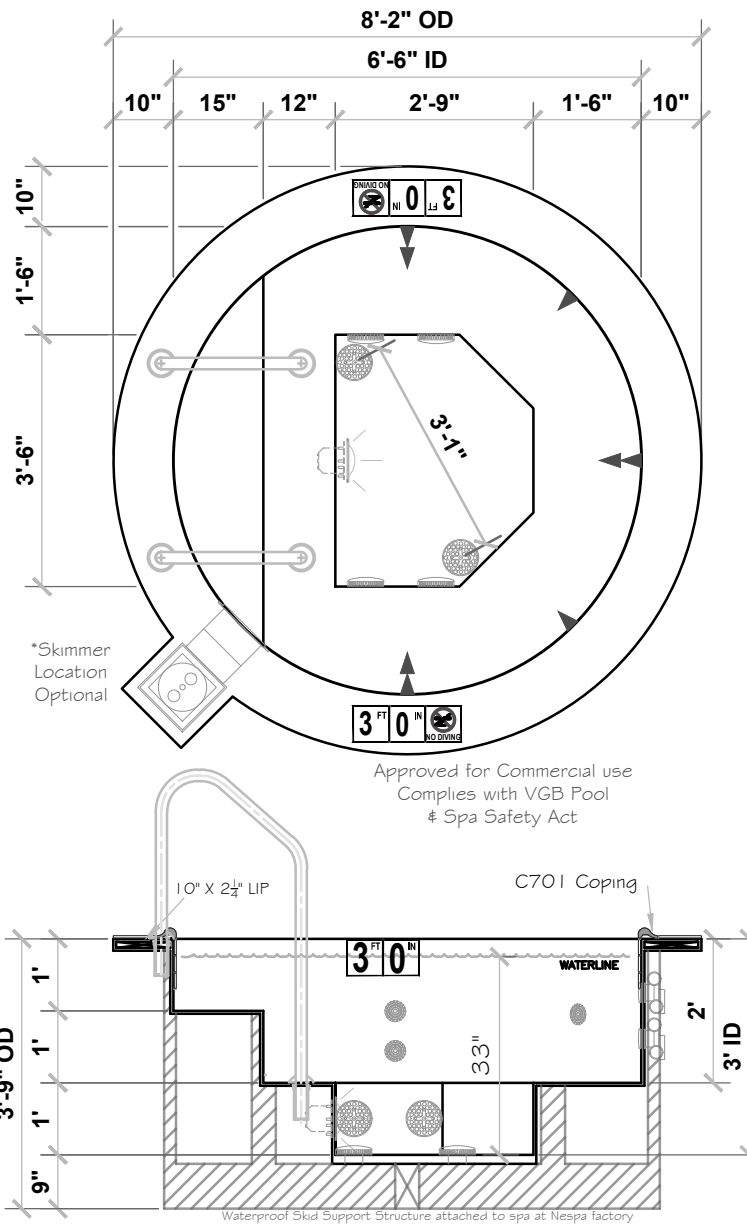













# 7' Round

## MDL# 503-LA

SPECIFICATIONS	
SHELL WEIGHT:	2000 LBS.
WATER WEIGHT:	4627 LBS.
TOTAL SHELL & WATER WEIGHT:	6627 LBS.
WATER VOLUME:	74 Cu.Ft.
WATER GALLONS:	555 GAL.
SURFACE AREA:	38.5 SQ. FT.
SPA LENGTH:	7'-0"
SPA WIDTH:	7'-0"
SPA DEPTH:	3'-0"
PEOPLE:	3
ICC ES LISTING #:	PMG-1161
USPC LISTING #:	SP14385

### LEGEND:



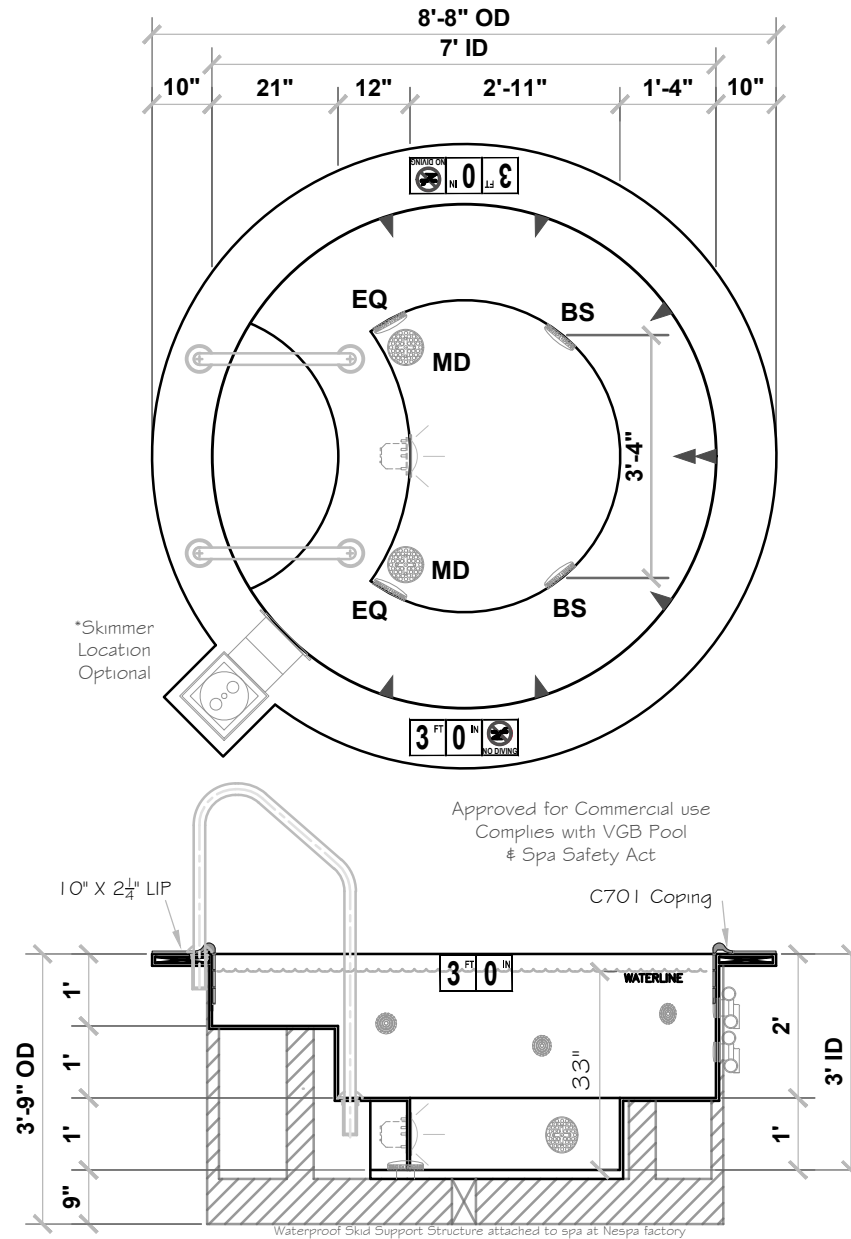









	SKIMMER	1
	MAIN DRAIN	2
	EQUALIZER	2
	B SUCTION	2
	JET	8
	RETURN	3
	WATER FILL	1
	STILLING	-
	VAC	-
	LIGHT	1
<b>WATERPROOF SKID SUPPORT STRUCTURE ATTACHED TO SPA AT NESPA FACTORY</b>   *SKIDS SUPPLIED BY NESPA		



# 8' Round MDL# 505-LA

SPECIFICATIONS	
SHELL WEIGHT:	2300 LBS.
WATER WEIGHT:	6215 LBS.
TOTAL SHELL & WATER WEIGHT:	8515.2 LBS.
WATER VOLUME:	99.4 Cu.Ft.
WATER GALLONS:	746 GAL.
SURFACE AREA:	50.3 SQ. FT.
SPA LENGTH:	8'-0"
SPA WIDTH:	8'-0"
SPA DEPTH	3'-2"
PEOPLE	5
ICC ES LISTING #	PMG-1161
USPC LISTING #	SP14385

## LEGEND:

	KIMMER	1
	MAIN DRAIN	2
	EQUALIZER	2
	B SUCTION	2
	JET	8
	RETURN	3
	WATER FILL	1
	STILLING	-
	VAC	-
	LIGHT	1
WATERPROOF SKID SUPPORT STRUCTURE ATTACHED TO SPA AT NESPA FACTORY   *SKIDS SUPPLIED BY NESPA		

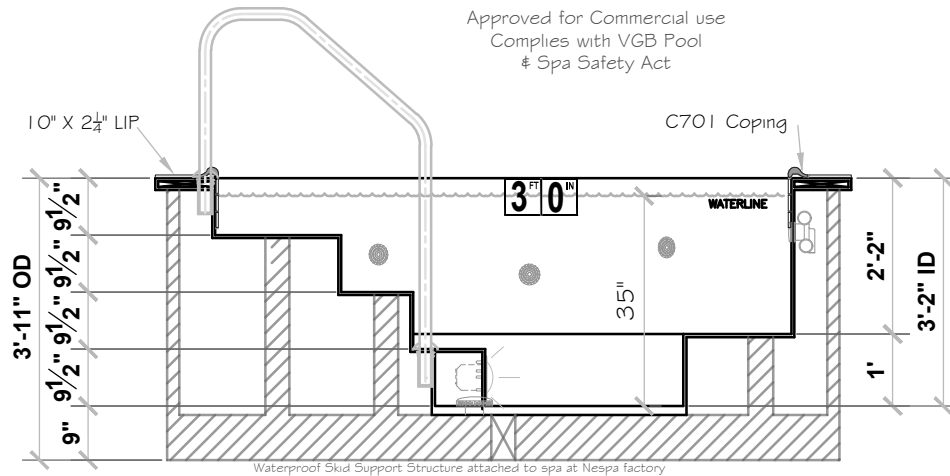
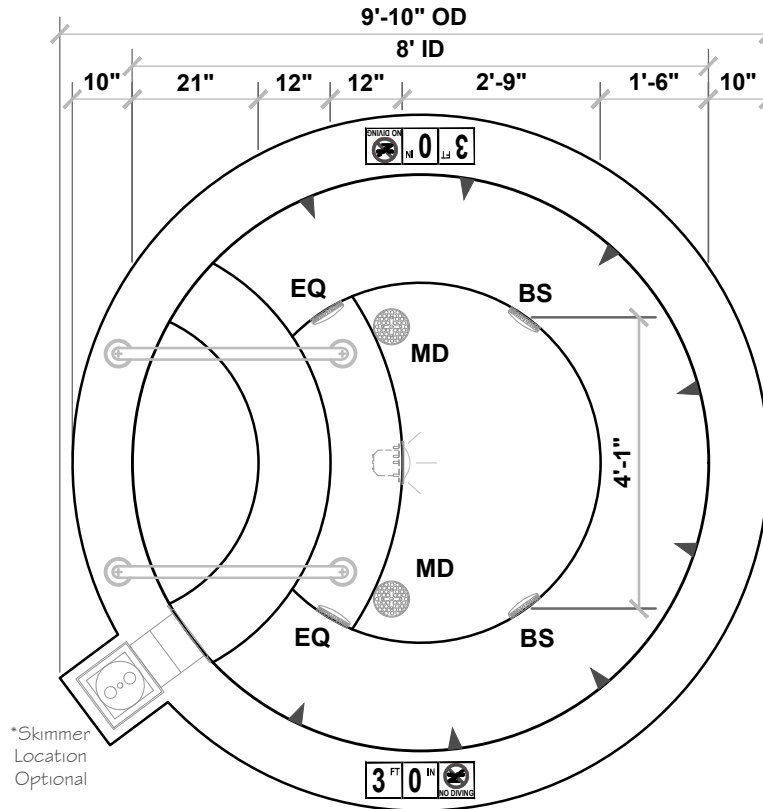















# 9' Round MDL# 507-LA

SPECIFICATIONS	
SHELL WEIGHT:	2600 LBS.
WATER WEIGHT:	8566 LBS.
TOTAL SHELL & WATER WEIGHT:	11166.3 LBS.
WATER VOLUME:	137 Cu.Ft.
WATER GALLONS:	1028 GAL.
SURFACE AREA:	63.6 SQ. FT.
SPA LENGTH:	9'-0"
SPA WIDTH:	9'-0"
SPA DEPTH	3'-4"
PEOPLE	6
ICC ES LISTING #	PMG-1161
USPC LISTING #	SP14385

## LEGEND:

	SKIMMER	1
	MAIN DRAIN	2
	EQUALIZER	2
	B SUCTION	4
	JET	10
	RETURN	3
	WATER FILL	1
	STILLING	-
	VAC	-
	LIGHT	1
WATERPROOF SKID SUPPORT STRUCTURE ATTACHED TO SPA AT NESPA FACTORY   *SKIDS SUPPLIED BY NESPA		

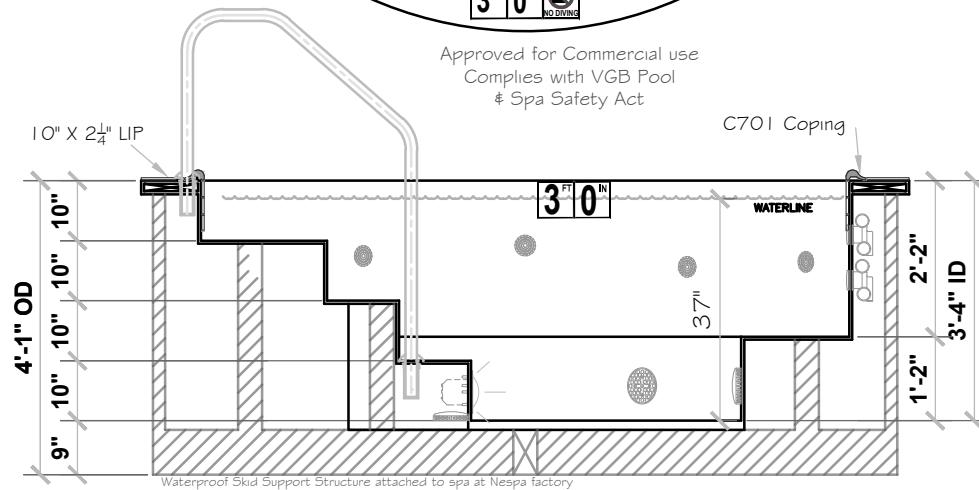
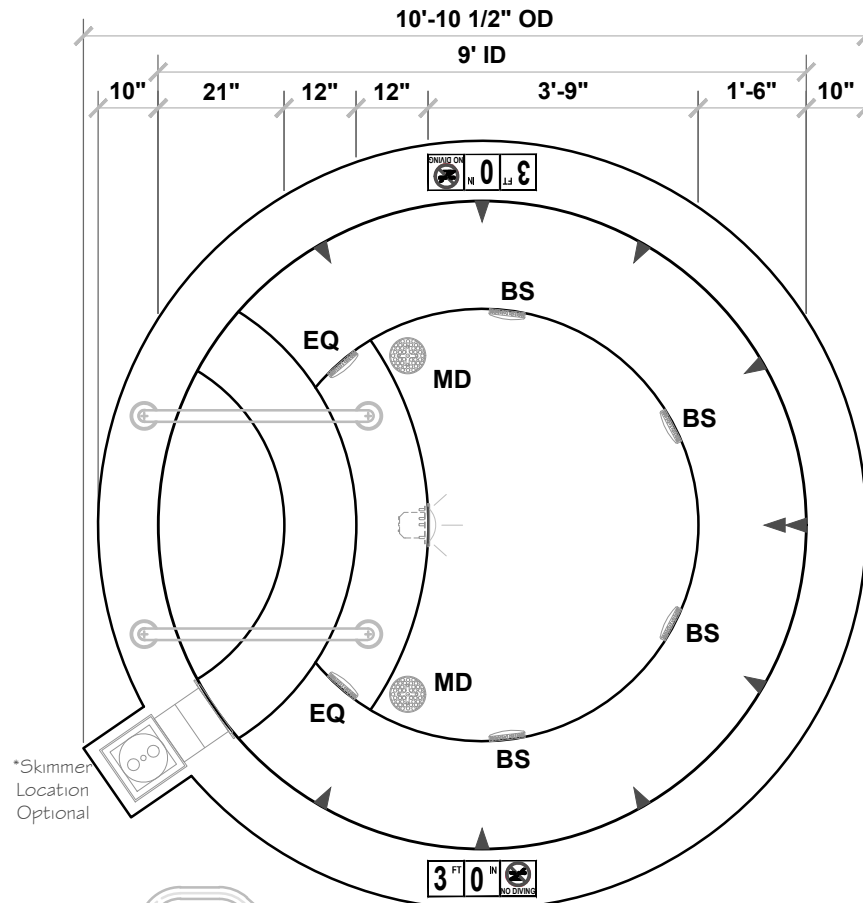

# 10' Round MDL# 509-LA

SPECIFICATIONS	
SHELL WEIGHT:	2800 LBS.
WATER WEIGHT:	10661 LBS.
TOTAL SHELL & WATER WEIGHT:	13460.9 LBS.
WATER VOLUME:	170.5 Cu.Ft.
WATER GALLONS:	1279 GAL.
SURFACE AREA:	78.5 SQ. FT.
SPA LENGTH:	10'-0"
SPA WIDTH:	10'-0"
SPA DEPTH	3'-2"
PEOPLE	7
ICC ES LISTING #	PMG-1161
USPC LISTING #	SP14385

## LEGEND:

	SKIMMER	1
	MAIN DRAIN	2
	EQUALIZER	2
	B SUCTION	4
	JET	11
	RETURN	3
	WATER FILL	1
	STILLING	-
	VAC	-
	LIGHT	1
WATERPROOF SKID SUPPORT STRUCTURE ATTACHED TO SPA AT NESPA FACTORY *SKIDS SUPPLIED BY NESPA		

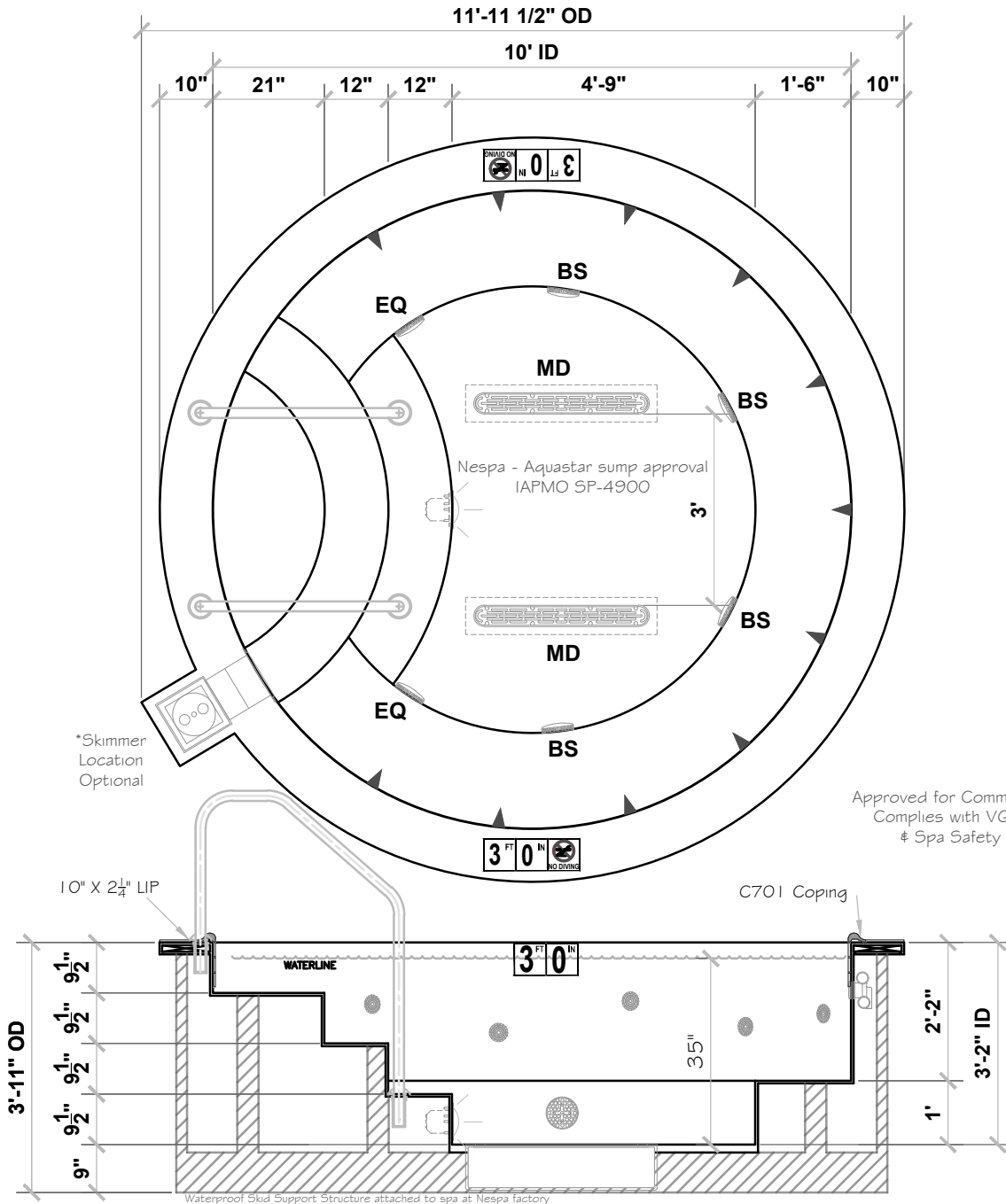

# 11' Round MDL# 510-LA

SPECIFICATIONS	
SHELL WEIGHT:	3000 LBS.
WATER WEIGHT:	13819 LBS.
TOTAL SHELL & WATER WEIGHT:	16818.6 LBS.
WATER VOLUME:	221 Cu.Ft.
WATER GALLONS:	1658 GAL.
SURFACE AREA:	95.0 SQ. FT.
SPA LENGTH:	11'-0"
SPA WIDTH:	11'-0"
SPA DEPTH	3'-4"
PEOPLE	9
ICC ES LISTING #	PMG-1161
USPC LISTING #	SP14385

## LEGEND:

	SKIMMER	1
	MAIN DRAIN	2
	EQUALIZER	2
	B SUCTION	4
	JET	13
	RETURN	3
	WATER FILL	1
	STILLING	-
	VAC	-
	LIGHT	1
WATERPROOF SKID SUPPORT STRUCTURE ATTACHED TO SPA AT NESPA FACTORY		
	*SKIDS SUPPLIED BY NESPA	

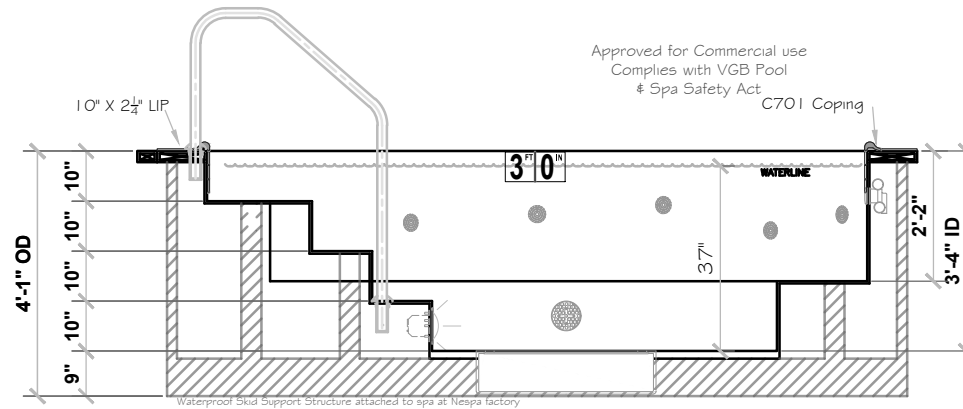
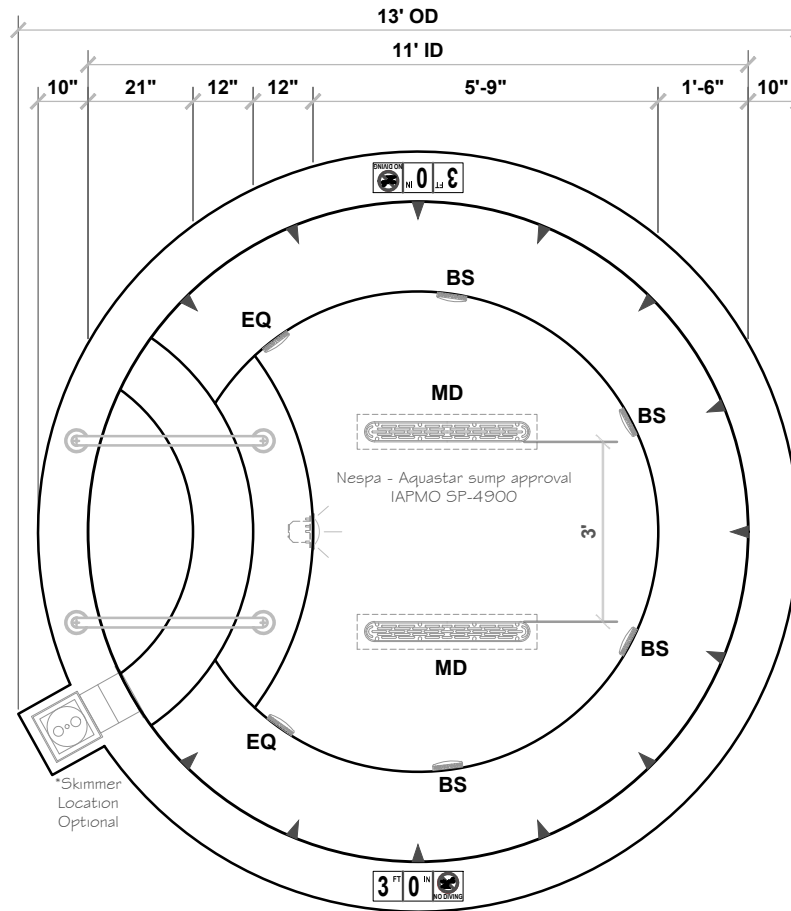

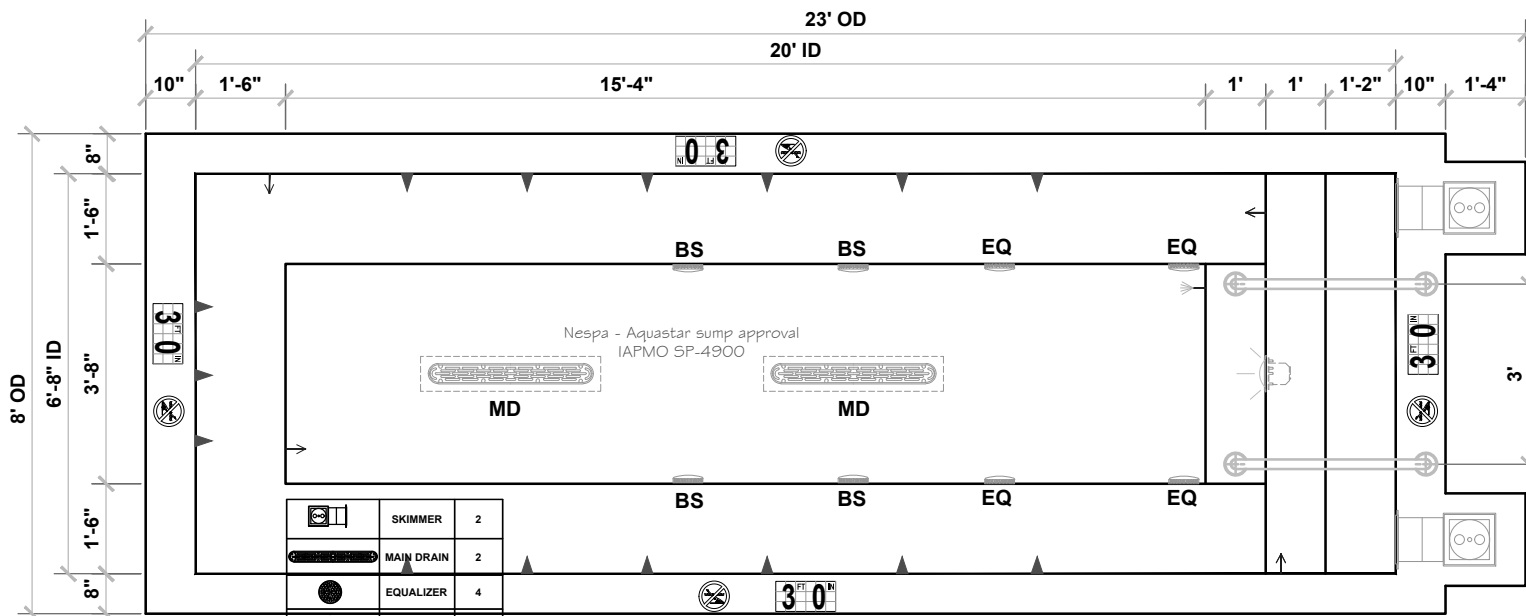

	SKIMMER	2
	MAIN DRAIN	2
	EQUALIZER	4
	B SUCTION	4
	JET	15
	RETURN	4
	WATER FILL	1
	STILLING	-
	VAC	-
	LIGHT	1

**SPECIFICATIONS**

SHELL WEIGHT:	3500 LBS.
WATER WEIGHT:	19893 LBS.
TOTAL SHELL & WATER WEIGHT:	23393.1 LBS.
WATER VOLUME:	319 Cu.Ft.
WATER GALLONS:	2386 GAL.
SURFACE AREA:	133.3 SQ. FT.
ICC ES LISTED #:	PMG-1161

**REDWOOD**

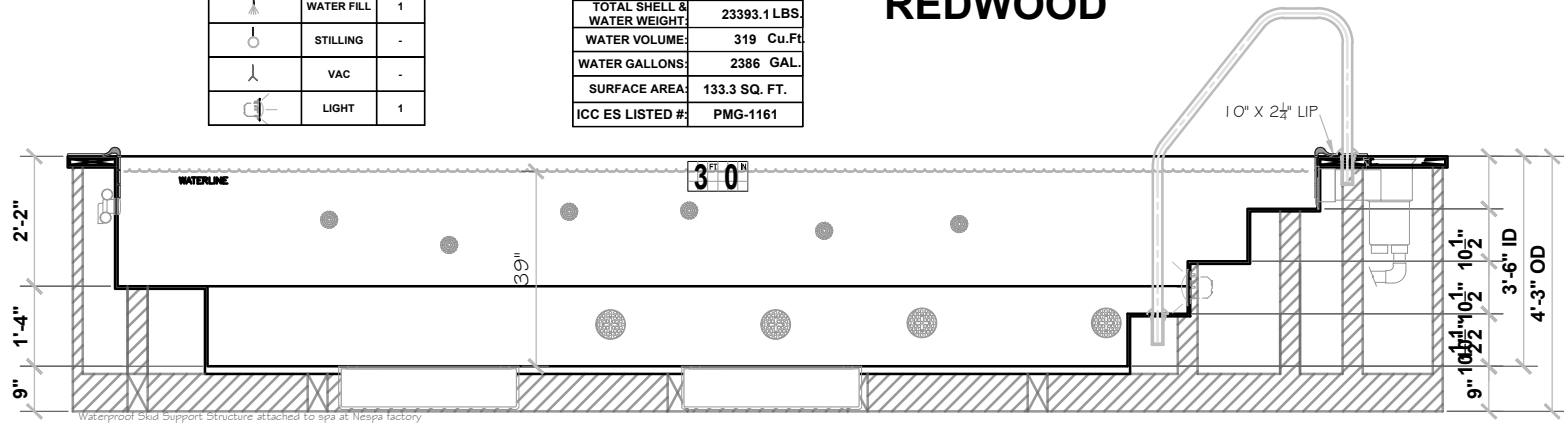











# 12' Serenity

## MDL# 302-LA

### SPECIFICATIONS

SHELL WEIGHT:	2200 LBS.
WATER WEIGHT:	10223 LBS.
TOTAL SHELL & WATER WEIGHT:	12423.2 LBS.
WATER VOLUME:	163.5 Cu.Ft.
WATER GALLONS:	1226 GAL.
SURFACE AREA:	73.5 SQ. FT.
SPA LENGTH:	9'-2"
SPA WIDTH:	7'-6"
SPA DEPTH	3'-6"
PEOPLE	7
ICC ES LISTING #	PMG-1161
USPC LISTING #	SP14385

### LEGEND:

	SKIMMER	1
	MAIN DRAIN	2
	EQUALIZER	2
	B SUCTION	4
	JET	14
	RETURN	3
	WATER FILL	1
	STILLING	-
	VAC	-
	LIGHT	1
<b>WATERPROOF SKID SUPPORT STRUCTURE ATTACHED TO SPA AT NESPA FACTORY</b>  *SKIDS SUPPLIED BY NESPA		

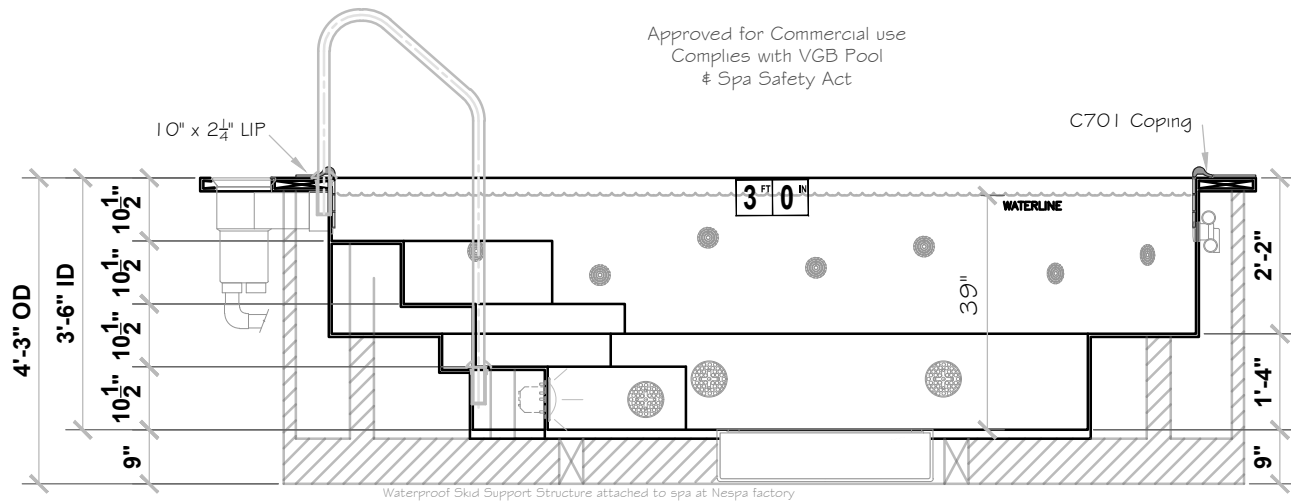
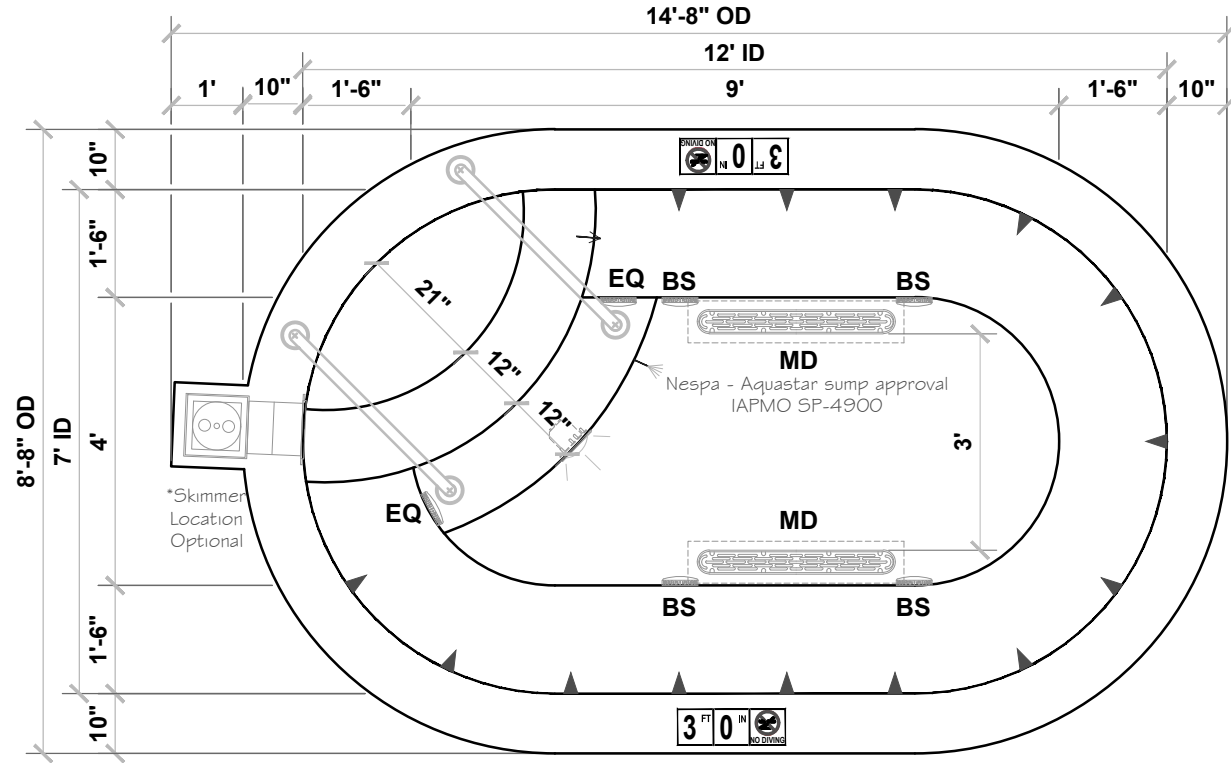

Approved for Commercial use  
Complies with VGB Pool  
& Spa Safety Act



# Nespa Swim Spa 12

## MDL# 802-LA

SPECIFICATIONS	
SHELL WEIGHT:	2300 LBS.
WATER WEIGHT:	11105 LBS.
TOTAL SHELL & WATER WEIGHT:	13404.9 LBS.
WATER VOLUME:	177.6 Cu.Ft.
WATER GALLONS:	1332 GAL.
SURFACE AREA:	77.6 SQ. FT.
SPA LENGTH:	12'-0"
SPA WIDTH:	7'-6"
SPA DEPTH:	3'-6"
PEOPLE	7
ICC ES LISTING #	PMG-1161
USPC LISTING #	SP14385

### LEGEND:

	SKIMMER	1
	MAIN DRAIN	2
	EQUALIZER	2
	B SUCTION	2
	JET	9
	RETURN	3
	WATER FILL	1
	STILLING	-
	VAC	-
	LIGHT	1
WATERPROOF SKID SUPPORT STRUCTURE ATTACHED TO SPA AT NESPA FACTORY *SKIDS SUPPLIED BY NESPA		

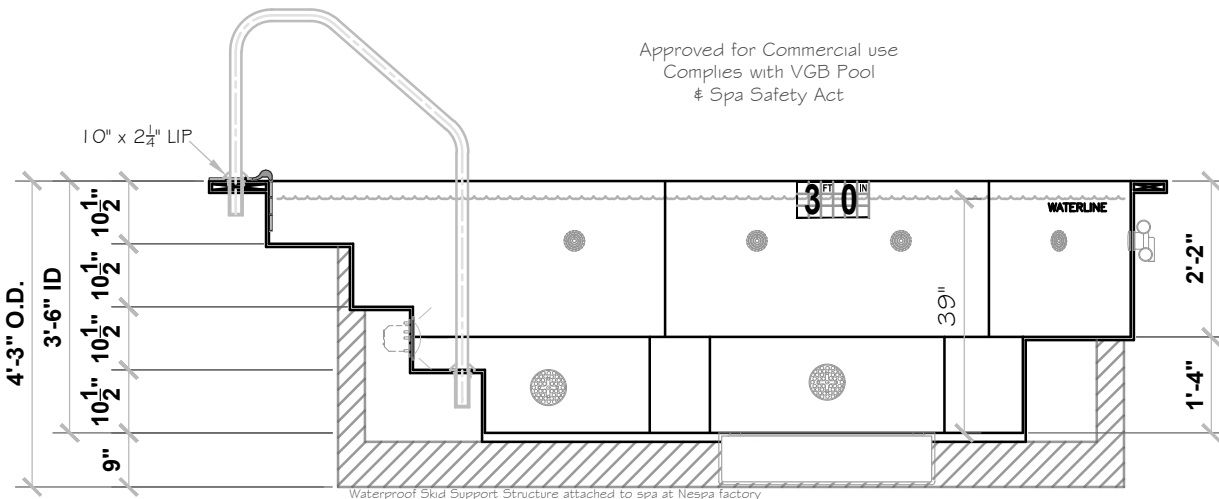
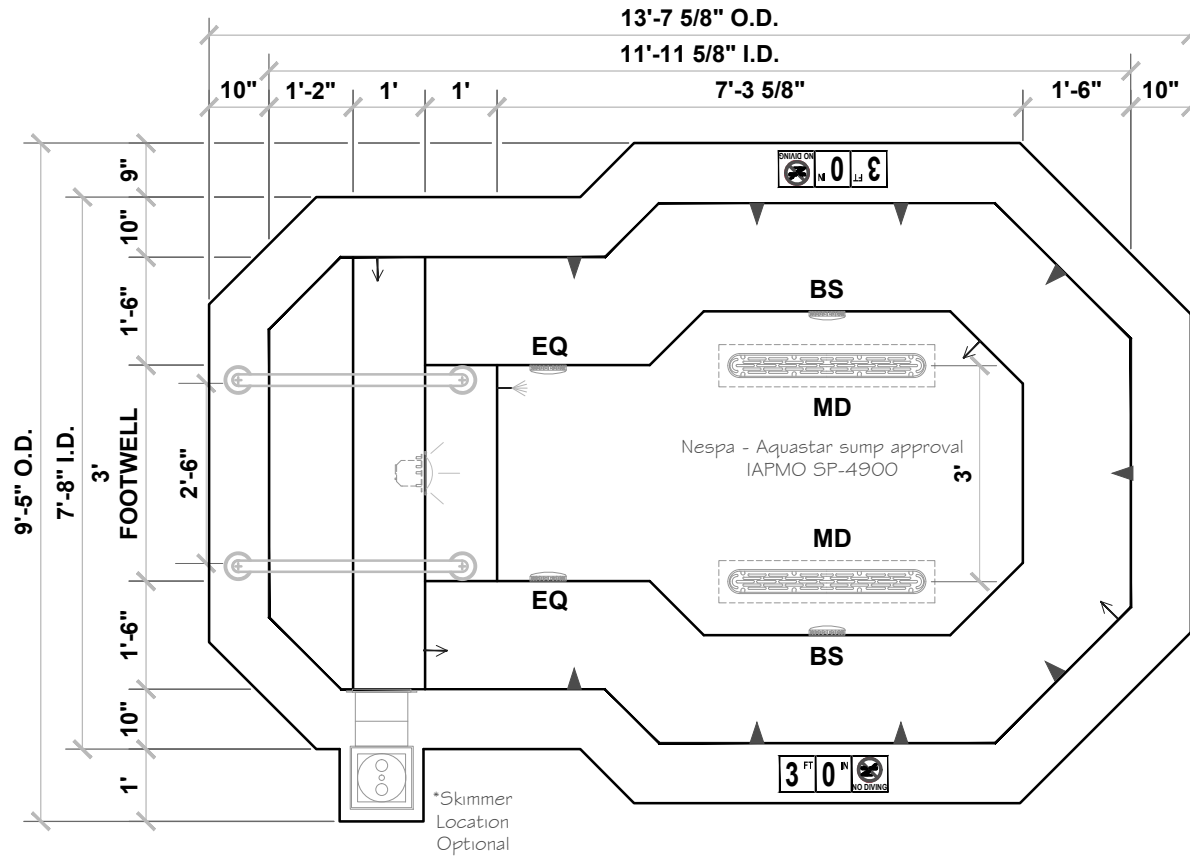

# Nespa Swim Spa 16 MDL# 804-LA

SPECIFICATIONS	
SHELL WEIGHT:	3100 LBS.
WATER WEIGHT:	16276 LBS.
TOTAL SHELL & WATER WEIGHT:	19375.9 LBS.
WATER VOLUME:	260.3 cu.Ft.
WATER GALLONS:	1952 GAL.
SURFACE AREA:	108.8 SQ. FT.
SPA LENGTH:	16'-0"
SPA WIDTH:	7'-6"
SPA DEPTH:	3'-6"
PEOPLE:	10
CC ES LISTING #:	PMG-1161
USPC LISTING #:	SP14385

### LEGEND:

	SKIMMER	2
	MAIN DRAIN	2
	EQUALIZER	4
	B SUCTION	2
	JET	13
	RETURN	4
	WATER FILL	1
	STILLING	-
	VAC	-
	LIGHT	1
WATERPROOF SKID SUPPORT STRUCTURE ATTACHED TO SPA AT NESPA FACTORY <small>*SKIDS SUPPLIED BY NESPA</small>		

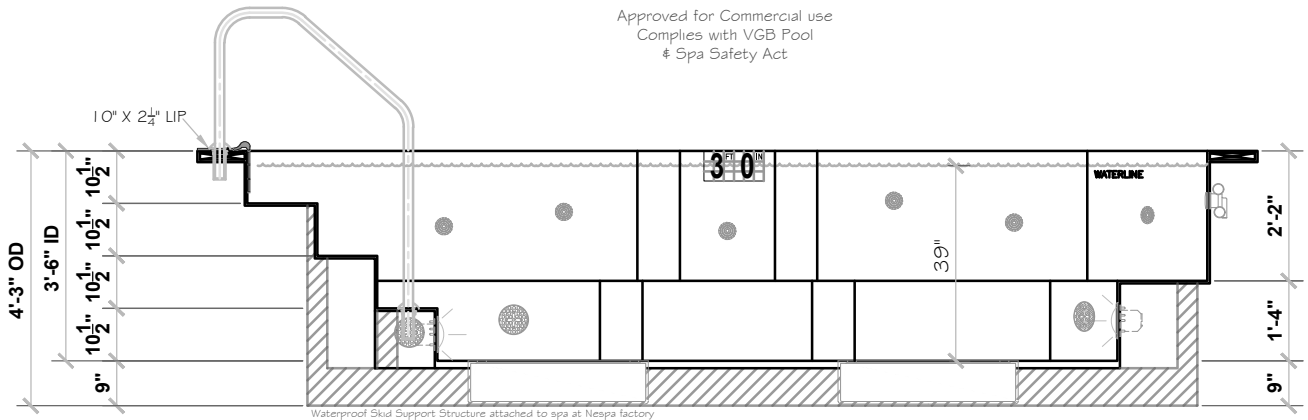
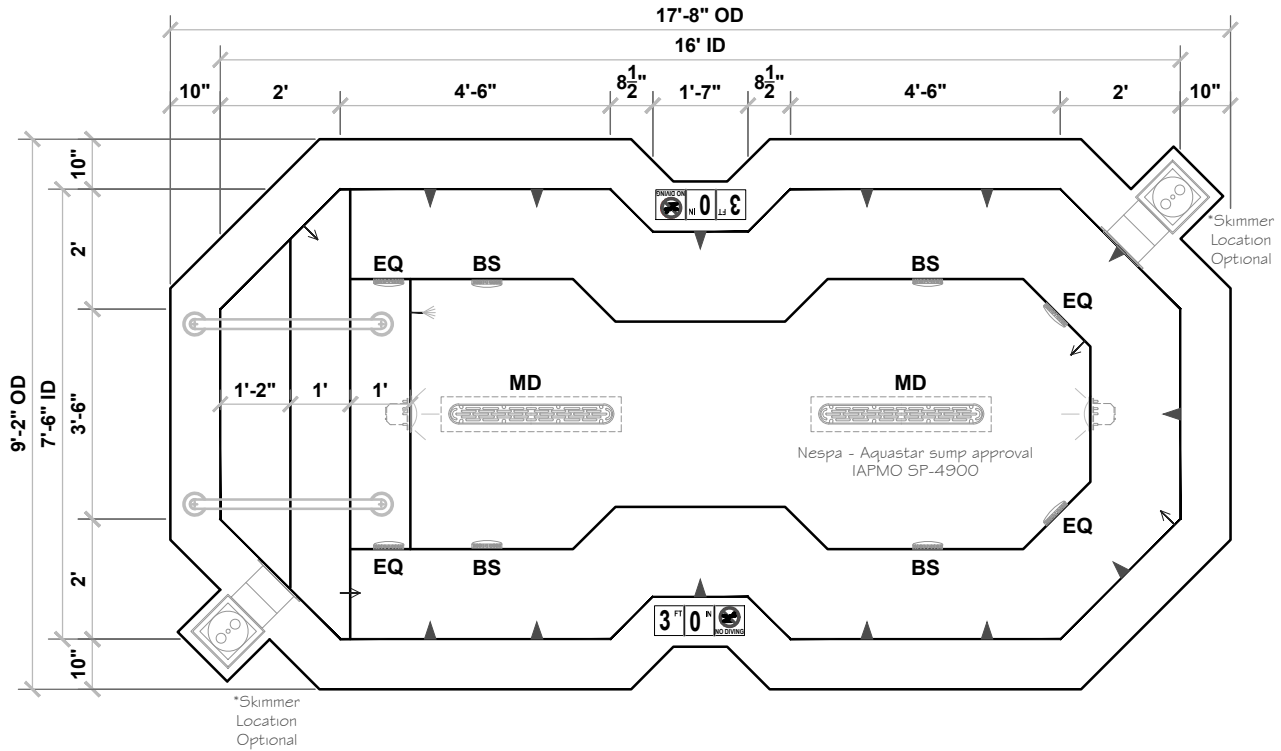

Approved for Commercial use  
Complies with VGB Pool  
& Spa Safety Act



# Nespa Swim Spa 18

## MDL# 805-LA

SPECIFICATIONS	
SHELL WEIGHT:	3350 LBS.
WATER WEIGHT:	18258 LBS.
TOTAL SHELL & WATER WEIGHT:	21608 LBS.
WATER VOLUME:	292 Cu.Ft.
WATER GALLONS:	2190 GAL.
SURFACE AREA:	120.9 SQ. FT.
SPA LENGTH:	18'-0"
SPA WIDTH:	7'-6"
SPA DEPTH:	3'-6"
PEOPLE:	12
ICC ES LISTING #	PMG-1161
USPC LISTING #	SP14385

### LEGEND:

	SKIMMER	2
	MAIN DRAIN	2
	EQUALIZER	4
	B SUCTION	4
	JET	15
	RETURN	4
	WATER FILL	1
	STILLING	-
	VAC	-
	LIGHT	1
WATERPROOF SKID SUPPORT STRUCTURE ATTACHED TO SPA AT NESPA FACTORY *SKIDS SUPPLIED BY NESPA		

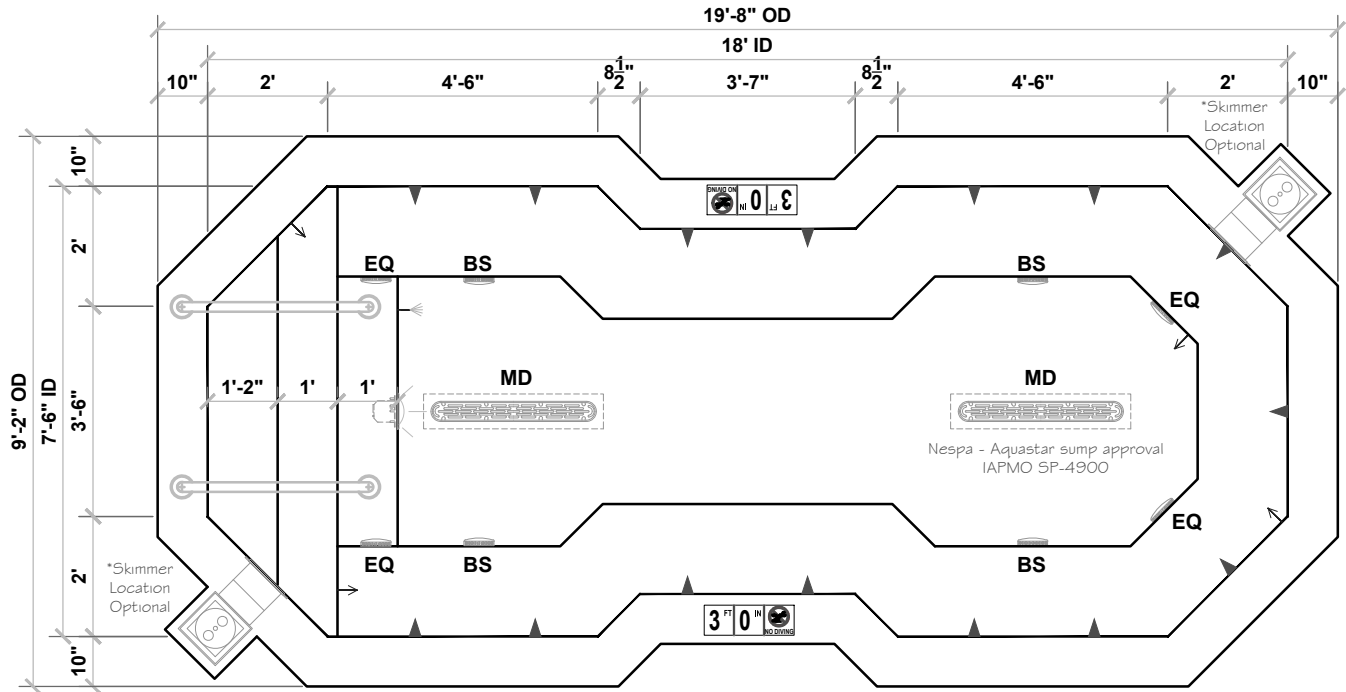

Approved for Commercial use  
Complies with VGB Pool  
& Spa Safety Act

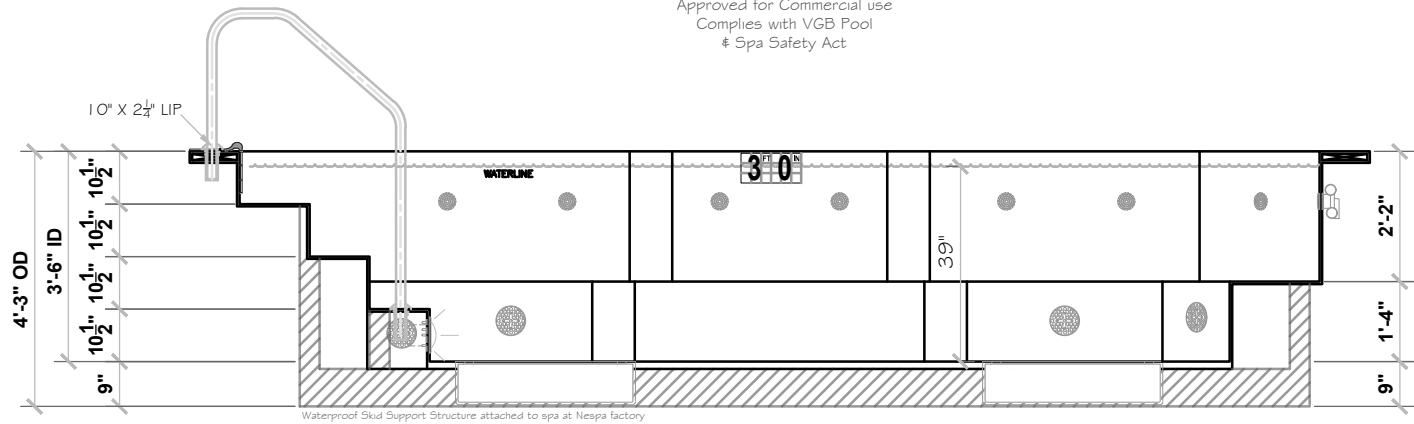



# Nespa Swim Spa 20 MDL# 806-LA

SPECIFICATIONS	
SHELL WEIGHT:	4000 LBS.
WATER WEIGHT:	20221 LBS.
TOTAL SHELL & WATER WEIGHT:	24221.4 LBS.
WATER VOLUME:	323.4 Cu.Ft.
WATER GALLONS:	2426 GAL.
SURFACE AREA:	133.1 SQ. FT.
SPA LENGTH:	20'-0"
SPA WIDTH:	7'-6"
SPA DEPTH:	3'-6"
PEOPLE:	13
ICC ES LISTING #	PMG-1161
USPC LISTING #	SP14385

## LEGEND:

	SKIMMER	2
	MAIN DRAIN	2
	EQUALIZER	4
	B SUCTION	2
	JET	13
	RETURN	4
	WATER FILL	1
	STILLING	-
	VAC	-
	LIGHT	1

WATERPROOF SKID SUPPORT STRUCTURE ATTACHED TO SPA AT NESPA FACTORY

\*SKIDS SUPPLIED BY NESPA

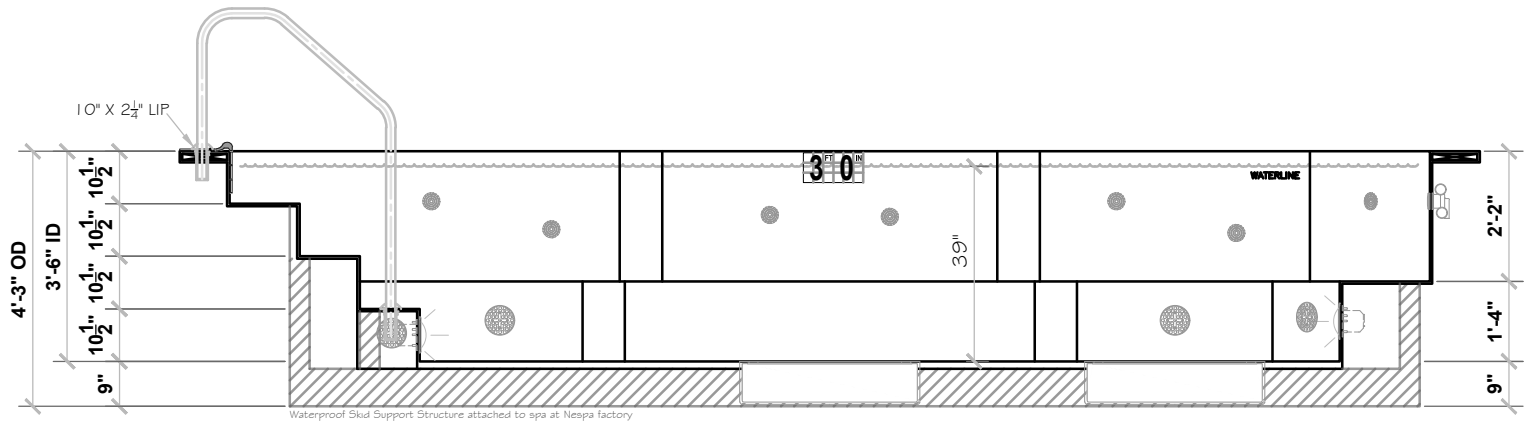
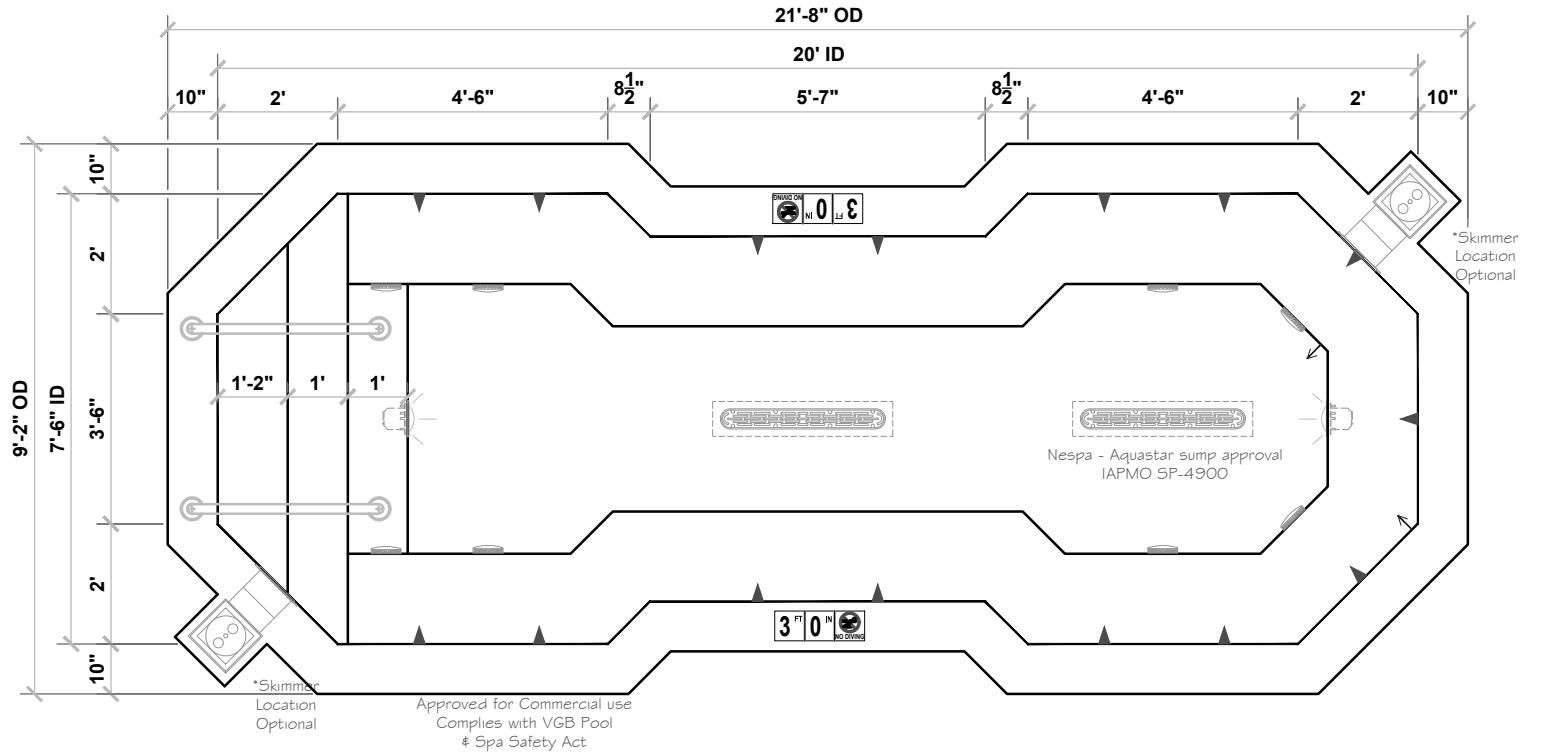

# Tahoe

## MDL# 301

SPECIFICATIONS	
SHELL WEIGHT:	2200 LBS.
WATER WEIGHT:	8279 LBS.
TOTAL SHELL & WATER WEIGHT:	10478.6 LBS.
WATER VOLUME:	132.4 Cu.Ft.
WATER GALLONS:	993 GAL.
SURFACE AREA:	62.7 SQ. FT.
SPA LENGTH:	9'-2"
SPA WIDTH:	7'-6"
SPA DEPTH	3'-6"
PEOPLE	6
ICC ES LISTING #	PMG-1161
USPC LISTING #	SP14385

### LEGEND:

	SKIMMER	1
	MAIN DRAIN	2
	EQUALIZER	2
	B SUCTION	2
	JET	9
	RETURN	3
	WATER FILL	1
	STILLING	-
	VAC	-
	LIGHT	1
<b>WATERPROOF SKID SUPPORT STRUCTURE ATTACHED TO SPA AT NESPA FACTORY</b> *SKIDS SUPPLIED BY NESPA		

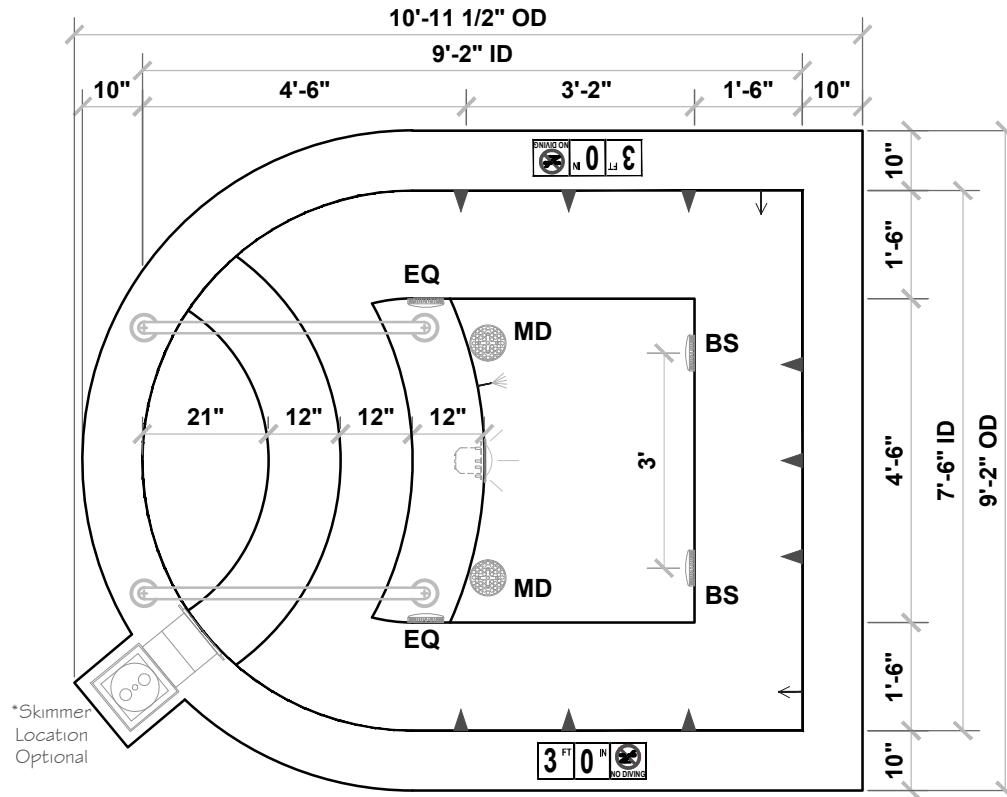

Approved for Commercial use  
Complies with VGB Pool  
& Spa Safety Act

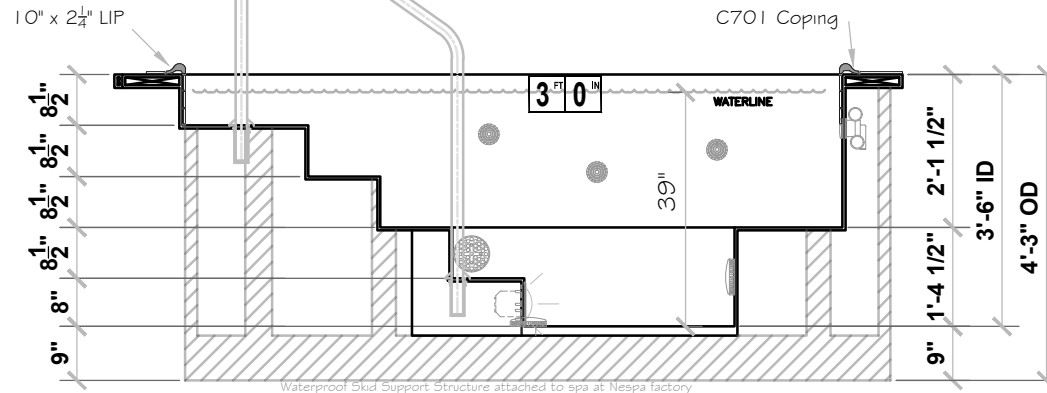



# Legacy 12 x 22 Pool

MDL# 7127

SPECIFICATIONS	
SHELL WEIGHT:	14000 LBS.
WATER WEIGHT:	60677 LBS.
TOTAL SHELL & WATER WEIGHT:	74676.7 LBS.
WATER VOLUME:	970.4 Cu.Ft.
WATER GALLONS:	7278 GAL.
SURFACE AREA:	263.8 SQ. FT.
SPA LENGTH:	22'-0"
SPA WIDTH:	12'-0"
SPA DEPTH	4'-0"
PEOPLE	15
ICC ES LISTING #	PMG-1161
USPC LISTING #	SP14385

## LEGEND:

	SKIMMER	2
	MAIN DRAIN	2
	EQUALIZER	4
	B SUCTION	-
	JET	-
	RETURN	5
	WATER FILL	1
	STILLING	-
	VAC	-
	LIGHT	2

WATERPROOF SKID SUPPORT STRUCTURE ATTACHED TO SPA AT NESPA FACTORY

\*SKIDS SUPPLIED BY NESPA

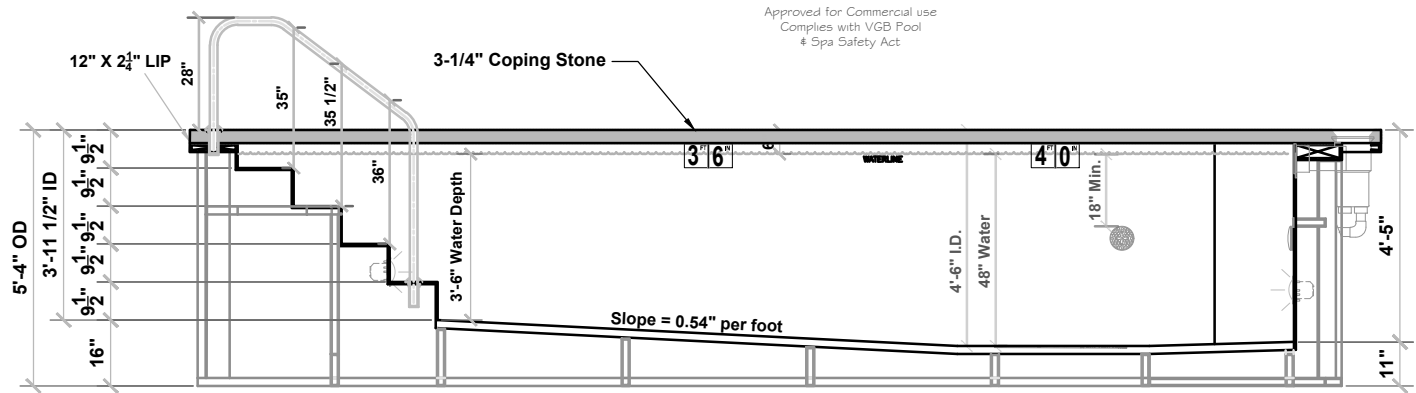
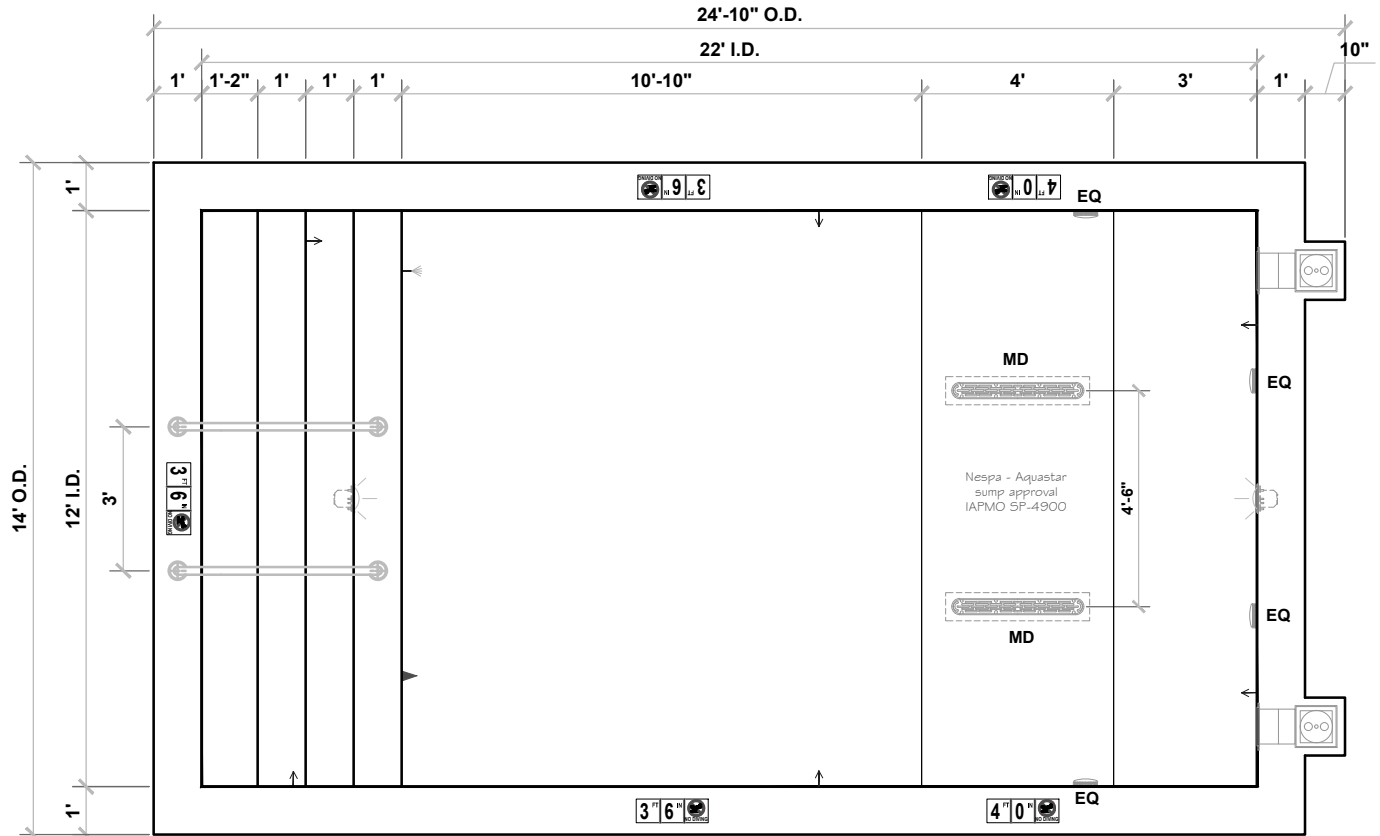

**Legacy**  
**12' x 18' CS**  
**MDL# 7124**

SPECIFICATIONS	
SHELL WEIGHT:	9000 LBS.
WATER WEIGHT:	44770 LBS.
TOTAL SHELL & WATER WEIGHT:	53769.7 LBS.
WATER VOLUME:	716 Cu.Ft.
WATER GALLONS:	5370 GAL.
SURFACE AREA:	216.3 SQ. FT.
SPA LENGTH:	18'-0"
SPA WIDTH:	12'-0"
SPA DEPTH:	4'-0"
PEOPLE	21
ICC ES LISTING #	PMG-1161
USPC LISTING #	SP14385

**LEGEND:**

	SKIMMER	2
	MAIN DRAIN	2
	EQUALIZER	4
	B SUCTION	-
	JET	-
	RETURN	5
	WATER FILL	1
	STILLING	-
	VAC	-
	LIGHT	3

WATERPROOF SKID SUPPORT STRUCTURE ATTACHED TO SPA AT NESPA FACTORY

\*SKIDS SUPPLIED BY NESPA

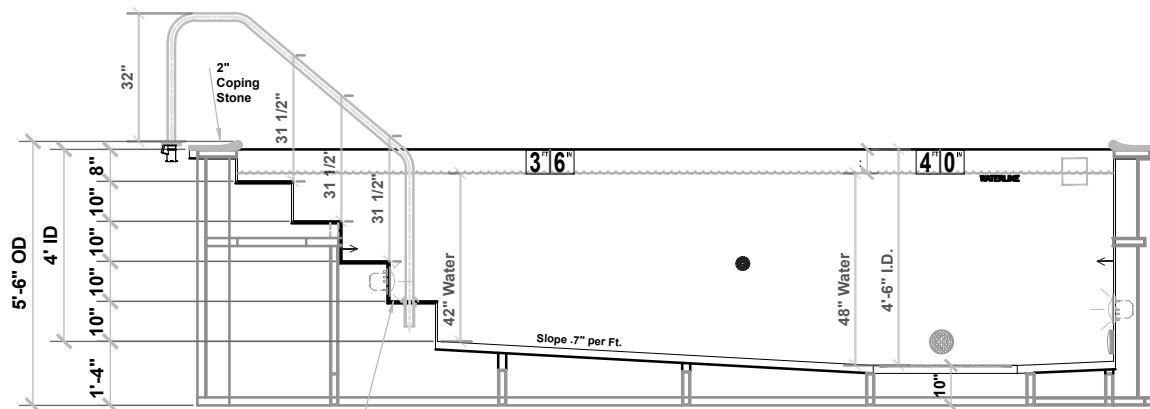
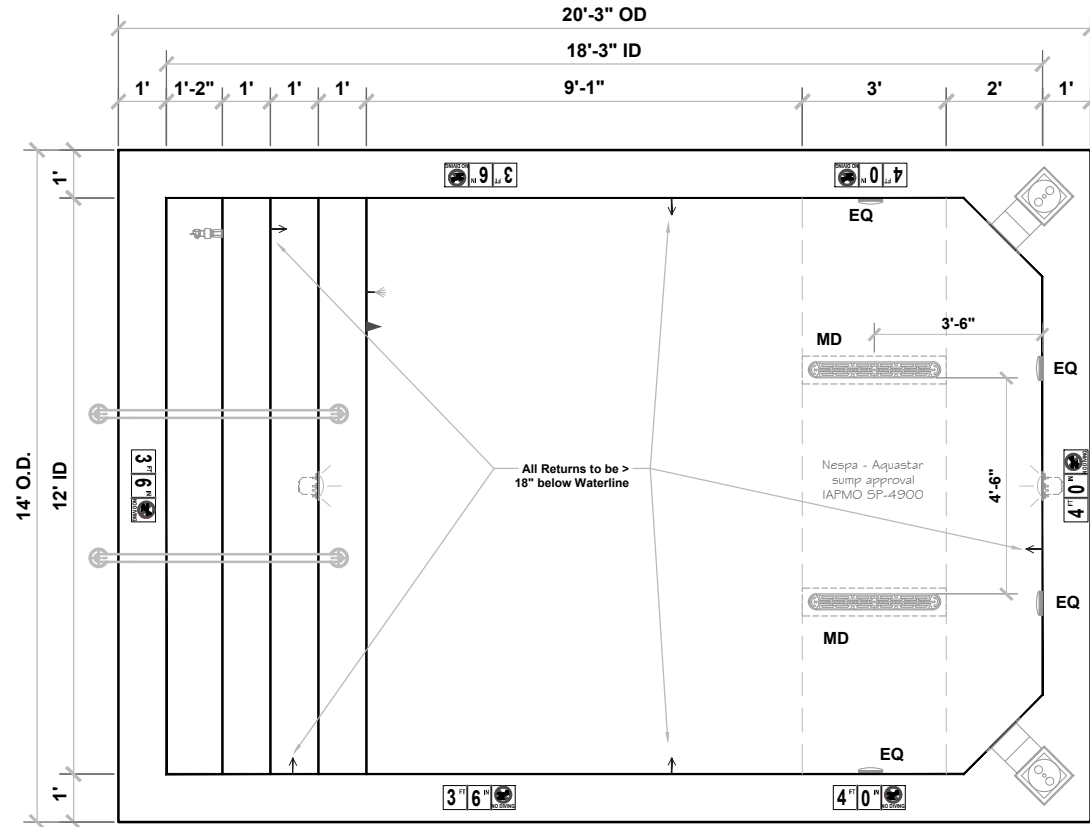

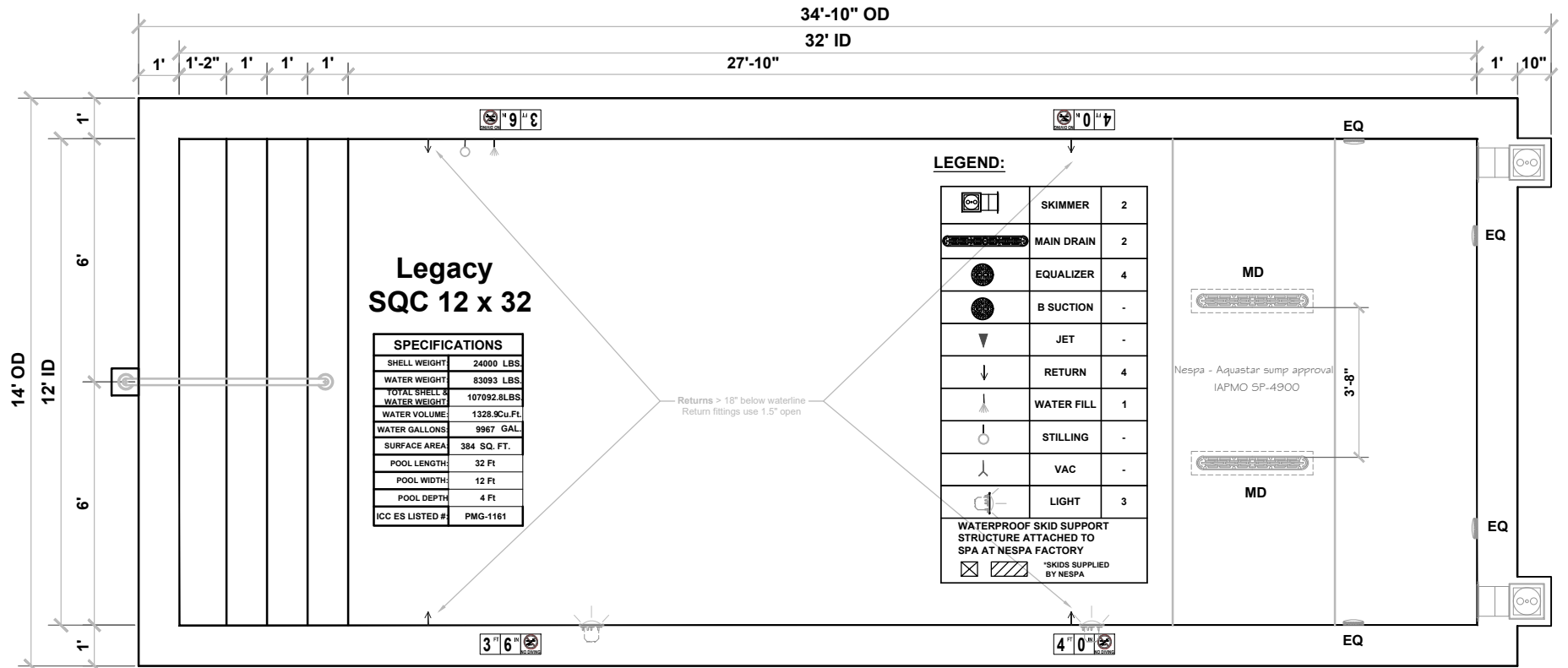

**Legacy  
SQC 12 x 32**

SPECIFICATIONS	
SHELL WEIGHT	24000 LBS.
WATER WEIGHT	83093 LBS.
TOTAL SHELL & WATER WEIGHT	107092.8LBS.
WATER VOLUME	1328.9Cu.Ft.
WATER GALLONS	9967 GAL.
SURFACE AREA	384 SQ. FT.
POOL LENGTH	32 Ft.
POOL WIDTH	12 Ft.
POOL DEPTH	4 Ft.
ICC ES LISTED #	PMG-1161

**LEGEND:**

	SKIMMER	2
	MAIN DRAIN	2
	EQUALIZER	4
	B SUCTION	-
	JET	-
	RETURN	4
	WATER FILL	1
	STILLING	-
	VAC	-
	LIGHT	3

WATERPROOF SKID SUPPORT STRUCTURE ATTACHED TO SPA AT NESPA FACTORY

\*SKIDS SUPPLIED BY NESPA

All corners / junctions of the Pool shall be covered.  
All horizontal surfaces shall be slip resistant tile.

Approved for Commercial use  
Complies with VGB Pool  
# Spa Safety Act

Waterline is at the middle of Skimmer mouth  
C701 Coping

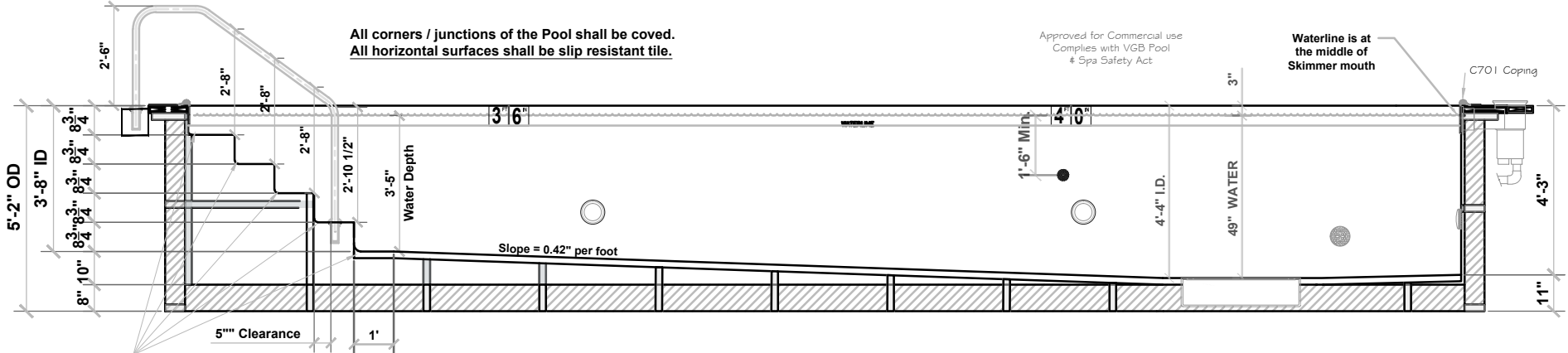

All corners / junctions of the Pool shall be covered.  
All horizontal surfaces shall be slip resistant tile.

# Modera Pool 1327

SPECIFICATIONS	
SHELL WEIGHT:	20000 LBS.
WATER WEIGHT:	68092 LBS.
TOTAL SHELL & WATER WEIGHT:	88092.4 LBS.
WATER VOLUME:	1089 Cu.Ft.
WATER GALLONS:	8168 GAL.
SURFACE AREA:	329.8 SQ. FT.
SPA LENGTH:	27'-6"
SPA WIDTH:	12'-0"
SPA DEPTH	4'-0"
PEOPLE	20
ICC ES LISTING #	PMG-1161
USPC LISTING #	SP14385

LEGEND:		
	SKIMMER	2
	MAIN DRAIN	2
	EQUALIZER	4
	B SUCTION	-
	JET	-
	RETURN	5
	WATER FILL	1
	STILLING	-
	VAC	-
	LIGHT	3
WATERPROOF SKID SUPPORT STRUCTURE ATTACHED TO SPA AT NESPA FACTORY *SKIDS SUPPLIED BY NESPA		

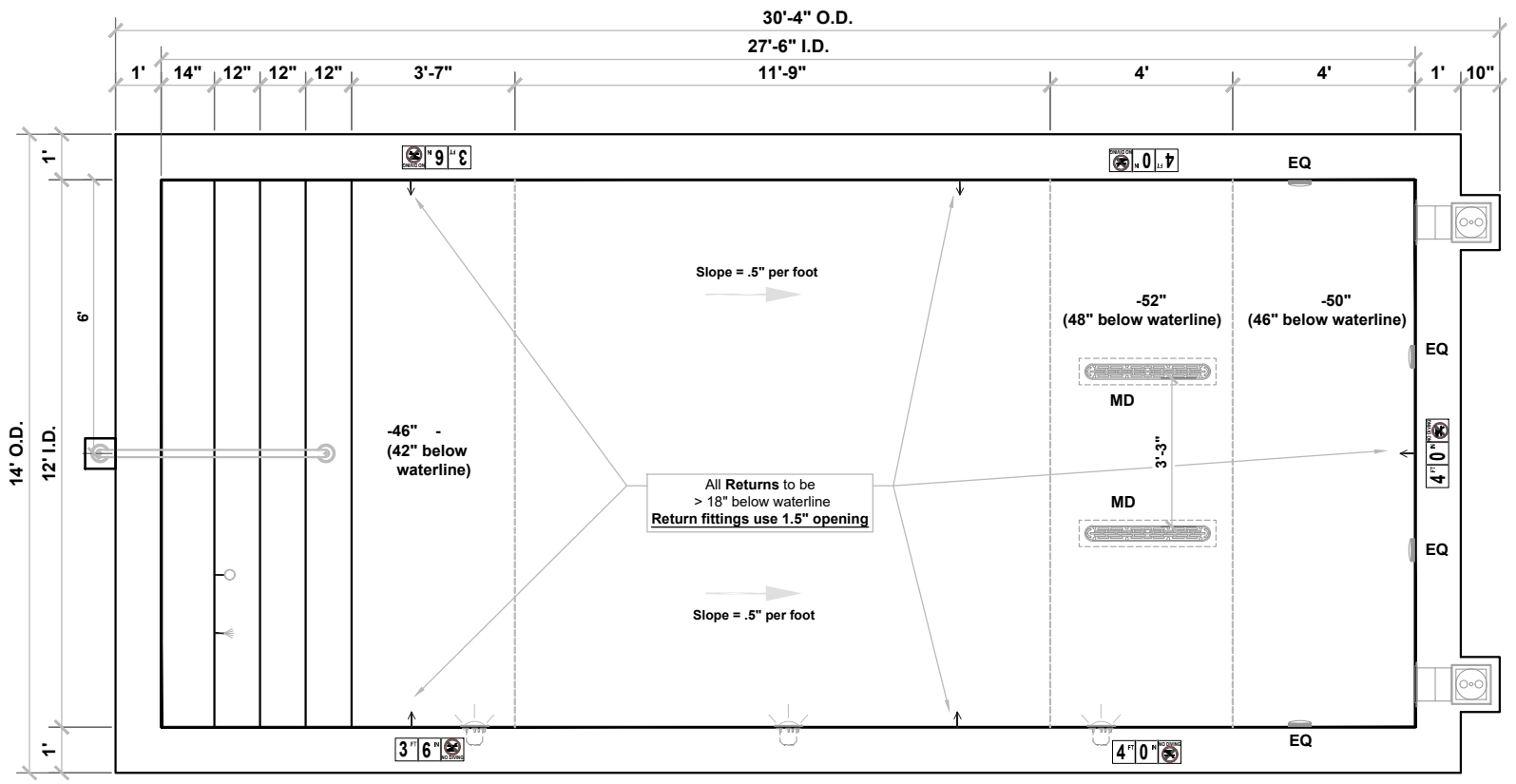

All corners / junctions of the Pool shall be covered.  
 All horizontal surfaces shall be slip resistant tile.

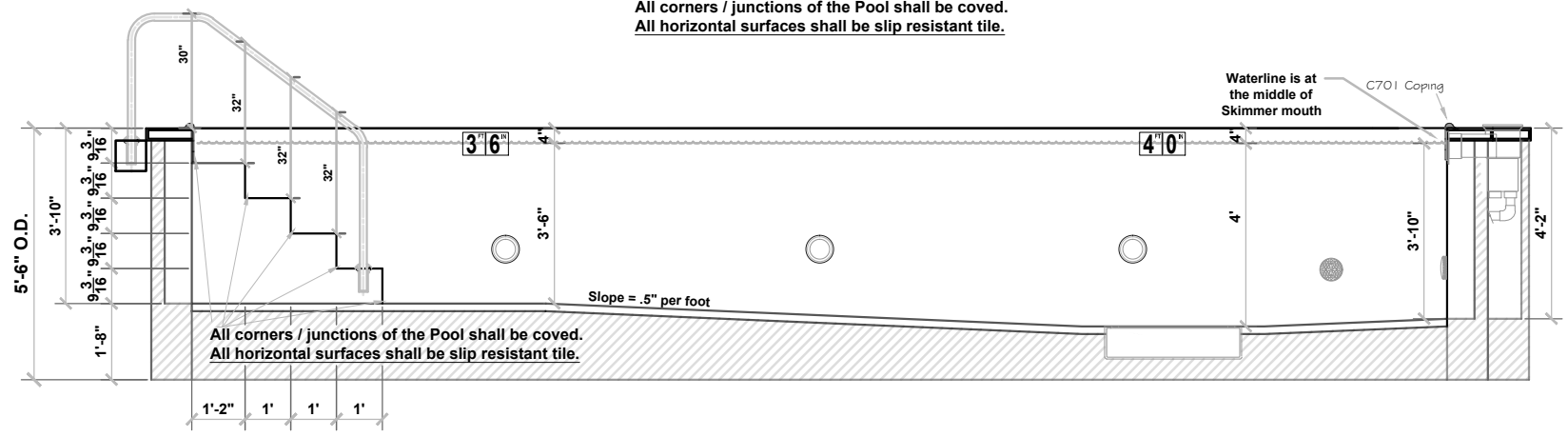



# NESPA TILED SPAS

## SPA DETAILS

---

2800 Richter Ave. Suite C, Oroville, CA 95965 • **voice:** (530)534-9910  
**email:** [jim@tiledspas.com](mailto:jim@tiledspas.com) • **website:** [www.tiledspas.com](http://www.tiledspas.com)



CSI: DIVISION: 13 00 00 – SPECIAL CONSTRUCTION  
Section: 13 17 00 – Tub and Pools

Product certification system:

The ICC-ES product certification system includes testing samples taken from the market or supplier's stock, or a combination of both, to verify compliance with applicable codes and standards. The system also involves factory inspections, and assessment and surveillance of the supplier's quality system.

Product: Spa Shell (Tile Lined FRP)

Listee: Nespa Enterprises, Inc.  
2800 Richter Avenue, Suite C  
Oroville, CA 95966  
[www.tiledspas.com](http://www.tiledspas.com)

Compliance with the following codes:

2024, 2021, 2018, 2015, 2012 and 2009 *International Swimming Pool and Spa Code*™ (ISPSC)  
2024, 2021, 2018, 2015, 2012 and 2009 *Uniform Swimming Pool, Spa and Hot Tub Code*®  
(USPSHTC)\*

\*Code is a copyrighted publication of the International Association of Plumbing and Mechanical Officials

Compliance with the following standards:

IAPMO/ANSI Z124.7-2013(R18), Prefabricated Plastic Spa Shells  
ANSI/APSP/ICC-3 2014, Permanently Installed Residential Spas and Swim Spas (formerly  
ANSI/NSPI-3 2014)

Identification:

Each unit of Spa Shell shall be marked with manufacturer's name or trademark and ICC-ES PMG mark of conformity. Marking shall be permanent and legible so as to be visible after installation. A label shall be permanently affixed to each unit in a visible location and shall include the manufacturer's name and/or trademark, and model designation. Units manufactured as "Shell Only" shall be so identified and labeled. Unit shall be permitted to be marked "IAPMO/ANSI Z124.7" signifying compliance with the standard.

Installation:

Each unit of Spa shell shall be installed in accordance with manufacturer's published installation instructions and applicable codes.

## Models:

Acapulco	Legacy 7.5' x 16' CS	Maxima II
Acapulco II	Legacy 7'4" x 17'10" CS	Mirage 9'
Acapulco III	Legacy 7'4" x 18' CS	Mirage 11'
Acapulco IV	Legacy 8' x 8' CS	Mirage 13'
Acapulco V	Legacy 8' x 10' C	Mirage 15'
6.5' Acapulco	Legacy 8' x 10' CS	Mirage 17'
7.2 Acapulco CS	Legacy 8' x 10' CS 46	Modera Pool 1327
7.5' Acapulco	Legacy 8' x 10' CS SR0313907	Modera Pool 1327 R10
9' Acapulco	Legacy 8' x 12' CS	Monaco
10' Acapulco	Legacy 8' x 14' CS	Nespa 12' x 15'
Alpha CP-1	Legacy 8' x 15' CS	Nespa 12' x 16'
Alpha CP-2	Legacy 8' x 16' DS	Nespa 12' x 18'
BERKELEY M	Legacy 8' x 18' DS	Nespa 12' x 20'
BERKELEY W	Legacy 8' x 20' DS	Nespa 12' x 22'
Blackthorne	Legacy 8' x 25' POOL	Nespa 12' x 24'
Capri	Legacy 10' x 18' DS	Nespa 12' x 15' C
Caribbean	Legacy 10' x 20' DS	Nespa 12' x 16' C
Caribbean C	Legacy 10' x 22' DS	Nespa 12' x 18' C
Cold Plunge Legacy 7.1' x 9.7'	Legacy 8' x 12' DSA	Nespa 12' x 20' C
Cold Plunge Legacy 7.1' x 9.7' SPA	Legacy 8' x 14' DSA	Nespa 12' x 22' C
Collective 4 <sup>th</sup>	Legacy 8' x 16' DSA	Nespa 12' x 24' C
Collective 15 <sup>th</sup>	Legacy 8' x 18' DSA	Nespa Pool Infinity 825
Commercial Models Octo 1	Legacy 8' x 20' DSA	Nespa Pool Infinity 1035
Commercial Models Octo 2	Legacy 8' x 22' DSA	Nespa Pool 1020 GTR
Commercial Models Octo 3	Legacy 8' x 25' Pool	Nespa Pool 1020 SKM
Corsica	Legacy 9' x 14' CS	Therapy Pool 1020-2W-CS
Corsica-Modified	Legacy 9' x 16' CS	Therapy Pool 1020-2W-Center
6' x 8' Corsica	Legacy 9' x 18' CS	Therapy Pool 1020-2W-ES-2RF
7' x 5.5' Corsica Cold Plunge	Legacy 10' x 10' CS	Nespa Swim Spa 12'
7' x 5.5' Corsica Spa	Legacy 10' x 12' CS	Nespa Swim Spa 16'
7' x 9' Corsica	Legacy 10' x 14' CS	Nespa Swim Spa 18'
8' x 10' Corsica	Legacy 10' x 16' C	Nespa Swim Spa 20'
Corsica II	Legacy 10' x 16' CS	Oval CP-1
Corsica III	Legacy 10' x 18' CS	PALISADES
Eight Ft. Round	Legacy 10' x 20' CS	PISMO POOL
GSW-1	Legacy 10' x 20' CS SR0313908	Redmond Ridge
GSW-2	Legacy 10' x 25' CS	REDWOOD
HC Dual Plunge	Legacy 12-10' x 28' QS	Rimini
HC Dual Plunge-2	Legacy 12-11' x 19-0' Pool	Rimini Commercial
Imperia	Legacy 12' x 18' CS	Rimini II
Imperia II	Legacy 12' x 20' CS	Rimini III
Imperia 6' x 7.5'	Legacy 12' x 20' DS	Rimini-Oak Grove
Imperia 7' x 7.5'	Legacy 12' x 28' DS	Rimini-Lilac
Imperia 5.5' x 7.5'	Legacy 12' x 18' CSW	Roman 625
Jensen Deluxe	Legacy 12' x 20' CSW	Round 7'
Mod. Imperia	Legacy 12' x 22' CSW	Round 9'
Kidney	Legacy 12' x 22' Pool	Round 11'
Legacy Pool Series	Legacy 12' x 24.5' Pool CS	6.5' Round
Legacy 45	Legacy 12' x 25' Pool	7.5' Round
Legacy C	Legacy 20' x 10'	8.5' Round
Legacy DW Series	Legacy 8420 CS	9 Round Mod
Legacy Infinity DS	Legacy C 12' x 32'	7.5 x 10 Corsica
Legacy M Series	Legacy HA 8'	Serenity 7'
Legacy Para	Legacy HA 10'	Serenity 8'
Legacy 10'	Legacy HA 12'	Serenity 9'
Legacy 12'	Legacy HA 14'	Serenity 10'
Legacy 14'	Legacy HA 16'	Serenity 12'
Legacy 16'	Legacy P-CS - 9 x 16	Six Ft. Round

Legacy 18'	Legacy P-CS - 9 x 18	Swim Pool - Spa Combo Rimimi 8
Legacy 20'	Legacy Serra 40G	Tahoe
Legacy 40	Legacy Serra 40S	Ten Ft. Round
Legacy 6' x 9' CS	Legacy SQC 8' x 20'	Therapy Pool
Legacy 6.3' x 10.3' CS	Legacy SQC 10' x 20' 3S	Therapy Pool 1016-15W-CS
Legacy 6.7' x 9.7'	Legacy SQC 12' x 32'	Therapy Pool 1018-2W-CS
Legacy 7-4' x 17-10' CS	Legacy SQC 12' x 32' SR0313909	Vallarta
Legacy 7.5' x 10' CS	Maxima	WALDORF

Tile lined, polyester resin reinforced fiberglass spa shells in various colors, sizes, and configurations. May or may not be provided with insulation. All units, whether factory or field assembled, are required to have suction fittings installed which are certified to ASME A112.19.8 or ANSI/APSP-16 for anti-hair and body entrapment. All units are listed for above or below ground installation and may be portable or permanent.

Conditions of listing:

1. NESPA's Spa Shell shall be installed in accordance with manufacturer's published installation instruction and applicable codes.
2. NESPA Spa Shell are under a quality control program with annual inspection by ICC-ES.

# STANDARD NESPA ABOVE GROUND INSTALLATION INSTRUCTIONS SET-UP AND PREPARATION

**Prerequisites:** Before installing your Nespa spa. You may be required to acquire a permit from your local State, County, and City Building Departments and or Health Department. (Commercial jobs need Health Dept. Approval). Your spa installation must comply with the most current codes. (**International Swimming Pool, Spas & Hot Tub Code 2021 (ISPSC 2021)**).

**Spa drawings:** Nespa Tiled Spas provides current spa specific construction details only. Spa plan, sections, Tile specification, spa plumbing detail. Each project has its own submittal drawings pertaining to spa vessel and plumbing only. Nespa vessels are free standing and supporting. No exterior lateral support is required. All building structural support for spa is by others. Do not rely on any website posted model. (Possibly outdated or custom)

**Delivery Access:** Clearly determine the method of getting the spa to jobsite and into the hole. This may require the use of a crane, forklift, hoist, backhoe and/or manpower etc. Each spa arrives with Spa lifting bolts for crane or rigging connections. This connection point is provided for crane or rigging connection. These eyebolts are removable after delivery.

ABOVE-GROUND The following instructions are general guidelines and may not apply to your specific jobsite conditions. Owner/Contractor to provide spa support structure capable of supporting spa load /weight with water and people. Owner/contractor all plumbing, electrical, control electrical and light connection clearances as required by code. This 10” clearance is to accommodate jet and suction plumbing. This 10” clearance can change or be reduced upon request. Note: skimmer location, this area may have to be larger than 10”, if commercial 22”.

- 1) **Freeze Climates-** If the spa is to be installed into a vault (typical of freeze climates) a standard clearance from vault wall to wall of spa should be 24” or more. If limited space is available contact Nespa for options. This area around spa is for possible future access to spa plumbing in case of a freeze. Area drain or sump pump in vault is mandatory. **Ask your local installer** for his experienced opinion. Do not hesitate to call us because we want to be sure that your installation progresses as smoothly as possible. If you have questions call us. (530) 534-9910.
- 2) **Hole depth** is determined by spa’s outside height dimension. This height may vary depending on if spa has skids or no skids. The spa lip may be finished or non-finished. How is the perimeter deck elevation transitioning to the spa? Focus on the finish surrounding deck elevations, thickness of the finish material on spa upper horizontal lip, equal to lip or under the spa lip. This material can be tile, stone, concrete or brick.
- 3) **Pre-plumb:** Nespa factory installs all fittings, suction and jets into spa before it goes into the hole. All vessels are factory water tested and plumbing is tested for 48 hours. If there are needs for electrical, bonding or control conduits run them as well before dropping in hole. Connecting a bond wire to the niche would be best practice.
- 4) **Support Pad:** Spa should sit on surface engineered to support the weight of vessel with water and people. Others to provide a level support platform. Support platform design and engineering is the responsibility of owner/contractor. Sweep debris off landing area prior to dropping in hole.
- 5) **Install spa** into the hole on top of support platform. Use the factory support lifting eye bolts provided for

crane, forklift rigging etc. Do not hold onto pipes. Use caution with suction and jet plumbing when lowering into hole. **DO NOT STRESS FITTINGS!** Fill Spa with water and check for leaks prior to backfill.

- 6) **Check site reference** points for proper spa positioning (i.e., squaring to house, garage, etc.).
- 7) **Shim to level spa.** Shim with non-compressible material. Re-square to house, or ref. point.
- 8) **Dry pack under spa support skids**, with cement, the gaps that have been created when shimming spa level.
- 9) **Connect pipes to tees** if spa is pre-plumbed. Installers should properly support your new plumbing from stressing the spas pre-plumbed fittings. After electrical conduit and bond wire is connected to light niche, water test spa before back filling with sand.

**NOTE: All Nespa products are water tested prior to leaving factory.**

### **ELECTRICAL:**

- 1) All electrical connections to spa or equipment shall comply with the most recent national electrical code (NEC), state and local codes.
- 2) Connect electrical conduit to light niche. This work shall be done or reviewed by a licensed electrician.
- 3) To install a spa light you will need to include, inside the PVC conduit to the light niche, a solid #8 coated copper wire. (If you are using brass conduit, internal bond wire is not required.) This bond wire should be pulled with the light cord at the same time. This bond wire needs to be attached to the internal bonding lug of the light niche. An approved encapsulate should be applied to bond wire connection in niche.
- 4) An external #8 copper wire shall be connected to the external bonding lug on the rear of the light niche. This copper wire can then be used for additional bonding requirements (i.e., handrails or any other metallic object within 5' of the spa).

### **PLUMBING:**

- 1) When plumbing a Nespa it is important to properly size the plumbing. We highly recommend that you follow the pump manufacturer's pipe sizing requirements and International Swimming Pool, Spas & Hot Tub Code 2021 (ISCSP 2021).
- 2) We recommend that you consult a pool professional to specify spa plumbing hydraulics.
- 3) The Nespa shells are water tested and pressure tested prior to shipping.
- 4) All plumbing inground or exterior to spa shell should be pressure tested at 35 psi (one hour minimum).
- 5) Fill spa with water and test the system for leaks.

### **WATERPROOFING**

- 1) Waterproofing is the responsibility of owner/contractor. Waterproof Spa Vault or containment structure to have area drain. Nespa does not provide waterproof guidelines, we recommend that owner hires waterproof professionals.
- 2) If spa is free standing on elevated deck or a structure, it is important to fill spa with water and load area prior to installing coping or perimeter decking. If spa is installed in a vault situation an area drain is needed.

#1

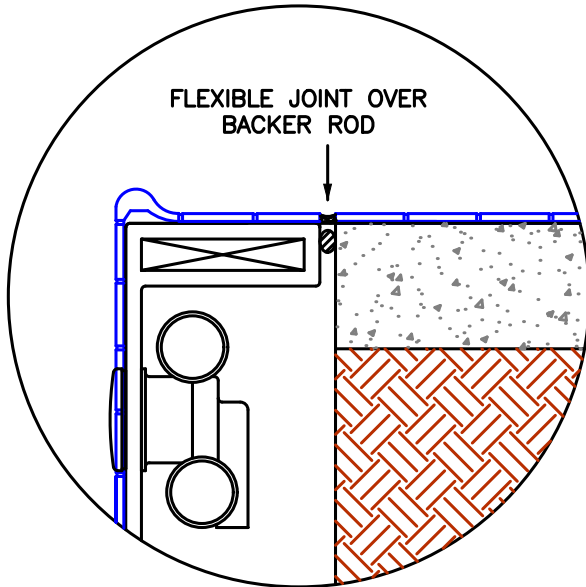

#2

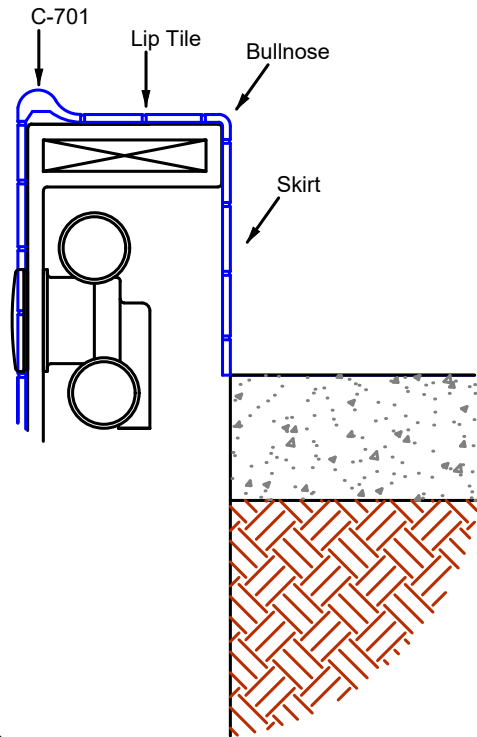

C701 Coping Tile  
for commercial application

**NESPA ENTERPRISES INC.**

2800 Richter Ave. Ste. C Oroville, CA 95966

Office: (530) 534-9910

E-Mail: [jim@tiledspas.com](mailto:jim@tiledspas.com) Web Site: [www.tiledspas.com](http://www.tiledspas.com)



**"A" Size Sheet**

SCALE  
N/A

DWG TYPE  
LIP DETAIL

DWG NAME

DETAILS 2024

DATE  
01/01/2024

SHEET  
PAGE 1 OF 1

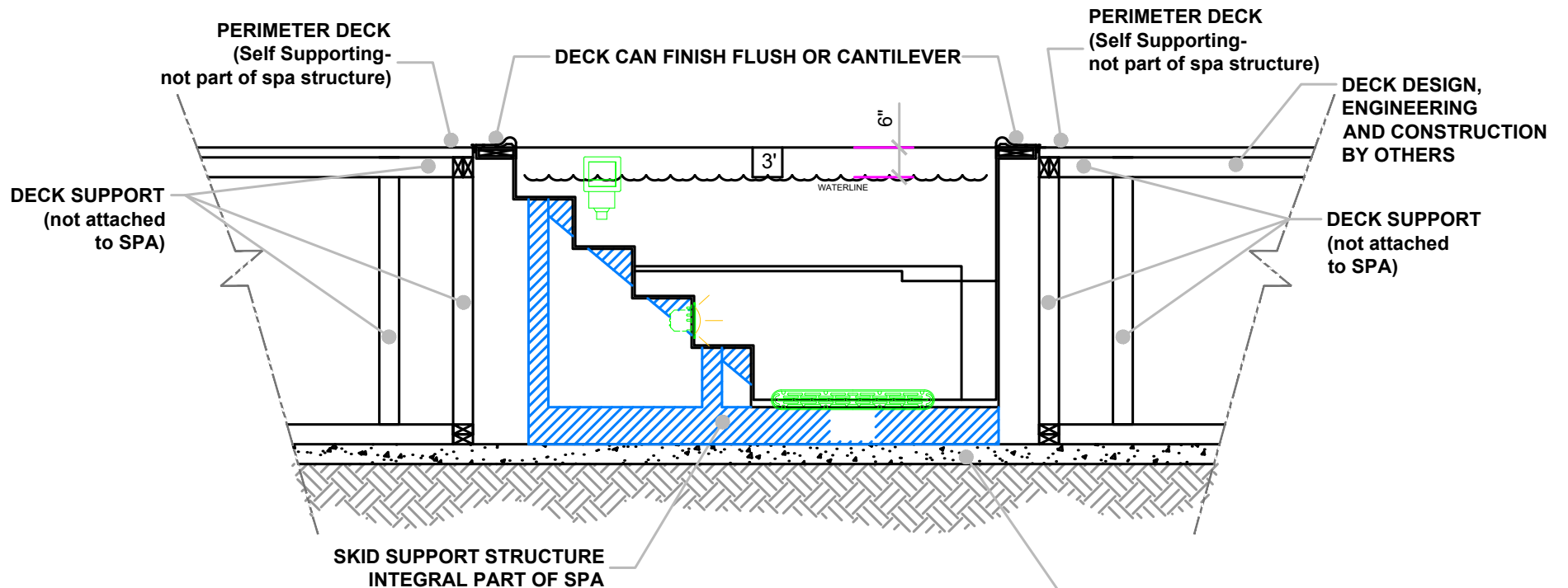

PLACE SPA ON SUITABLE LEVEL SUPPORT PAD WHICH MAY BE PREPARED FOR VARIOUS HEIGHT ELEVATIONS OF THE SPA; ABOVE THE FINISH FLOOR, TOTALLY RECESSED INTO THE FLOOR OR ON-GRADE.

## ABOVE GROUND INSTALLATION Commercial



NOTE:  
Sump pump or gravity drain is  
required for removing water from  
vault

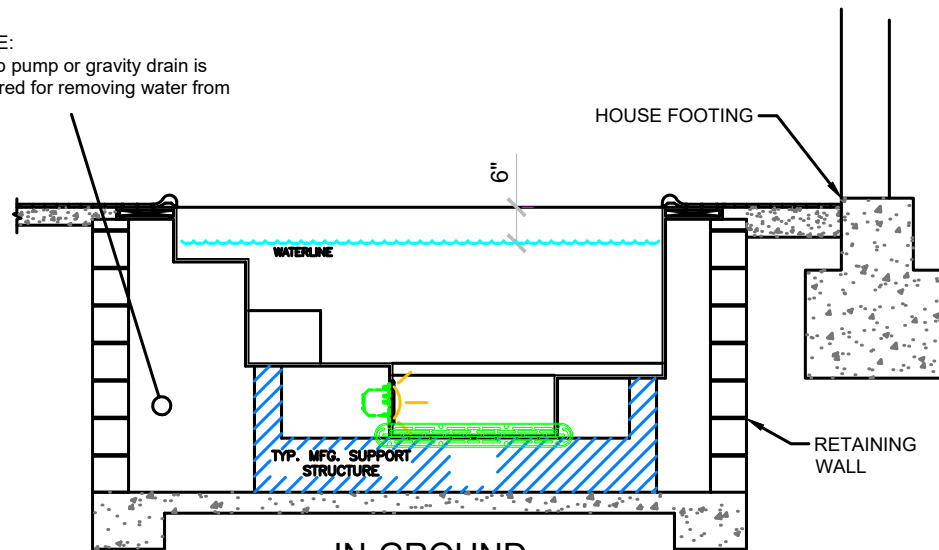

**IN-GROUND  
INSTALLATION  
CIG-1**

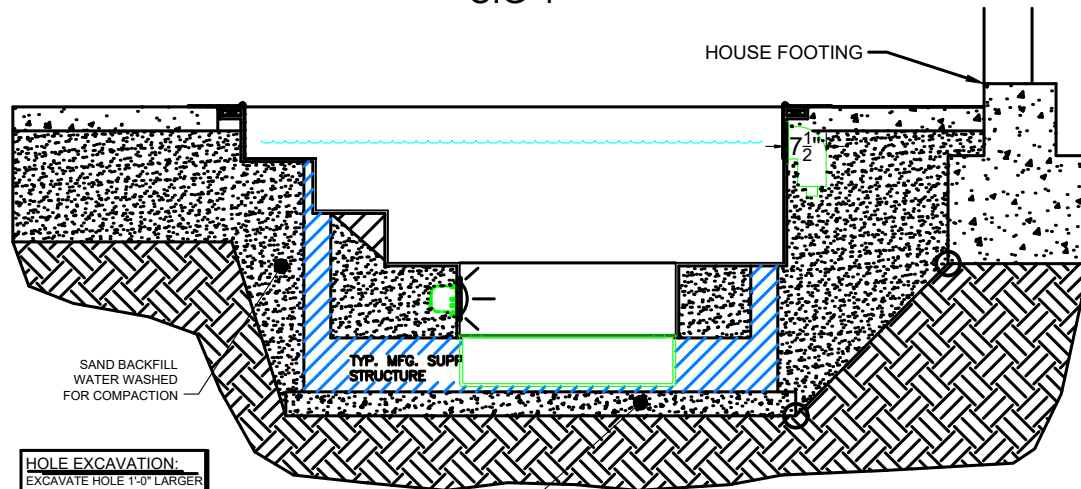

**HOLE EXCAVATION:**  
EXCAVATE HOLE 1'-0" LARGER  
THAN THE OUTSIDE  
DIAMETER (OD) OF SPA

4" CONCRETE SLAB  
REINFORCED WITH  
#10 MESH

NOTE:  
Footing can not surcharge spa.  
Slope from bottom of slab to nearest  
corner of house footing must not  
exceed 1" = 1".

**IN-GROUND  
INSTALLATION  
CIG-2**





- #1 - FIELD TILE: DAL TILE D317 BISQUIT 2 X 2  
Fujiwa 3x3 BLACK
- #2 - WATERLINE : VIP 714 - Gloss Finish
- #3 - TRIM TILE: DAL TILE 2x2 BLACK  
D311 - Matte Finish
- #4 - TILED LIP (Edge Trim): DAL TILE C701 - D311 Black Matte
- #5 - TILED LIP (Horizontal Field): TileTech Porcelain Pavers  
FLAT ASH - 24" X 24"

DATE: \_\_\_\_\_

APPROVAL: \_\_\_\_\_

**GROUT**

- #1 - SPA Field Grout: CCure Epoxy White
- #2 - SPA Waterline Grout: Nespa Epoxy Blue
- #3 - SPA Horizontal Lip Grout: CCure Epoxy White

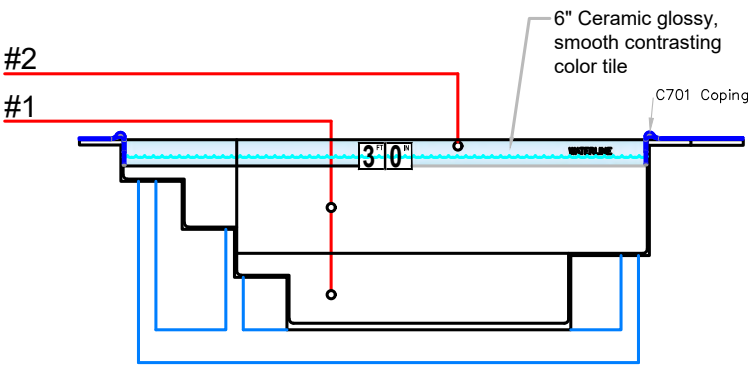
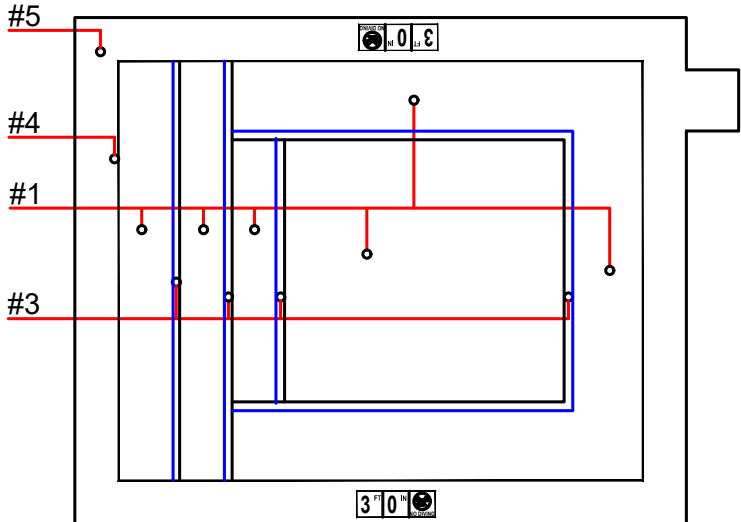
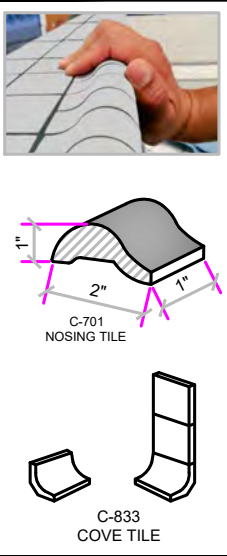
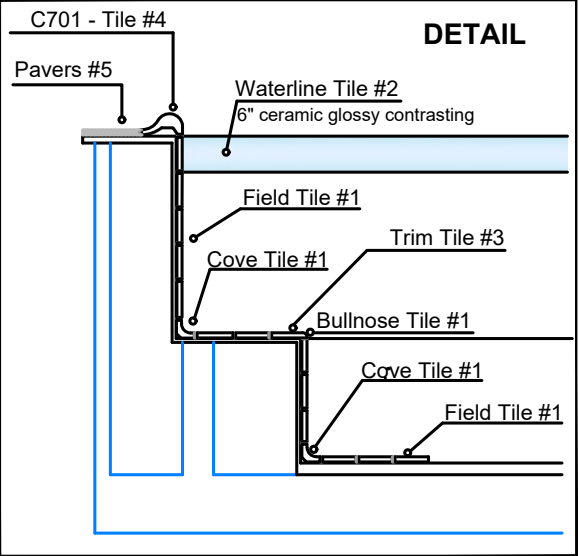
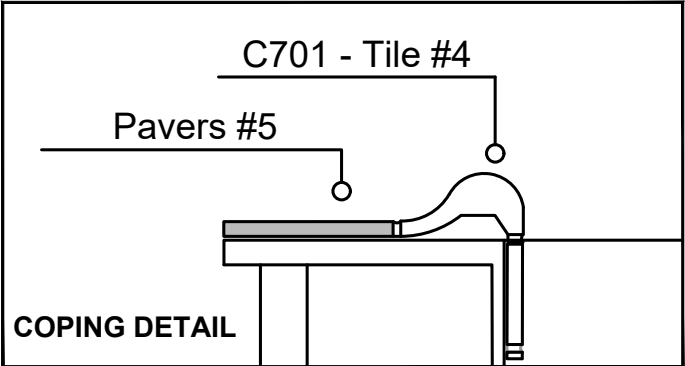

All corners / junctions of the Pool shall be covered.  
All horizontal surfaces shall be slip resistant tile.



DATE: \_\_\_\_\_  
 APPROVAL: \_\_\_\_\_

- #1 - FIELD TILE: DAL TILE D617 Arctic White 2 X 2
- #2 - WATERLINE: Fujiwa 3x3 BLACK  
VIP 714 - Gloss Finish
- #3 - TRIM TILE: DAL TILE 2x2 BLACK  
D311 - Matte Finish
- #4 - TILED LIP (Edge Trim): DAL TILE C701 - D311 Black Matte
- #5 - TILED LIP (Horizontal Field): Tile Tech Porcelain Paver  
Flat ASH 24x24



**GROUT**

- #1 - SPA Field Grout: Mapai Kerapoxy Epoxy White
- #2 - SPA Waterline Grout: Mapai Kerapoxy Charcoal
- #3 - SPA Horizontal Lip Grout: Mapai Kerapoxy Charcoal

POOL SHALL BE WHITE IN COLOR WITH NO LETTERS, MARKINGS OR DESIGNS EXCEPT FOR SAFETY MARKINGS

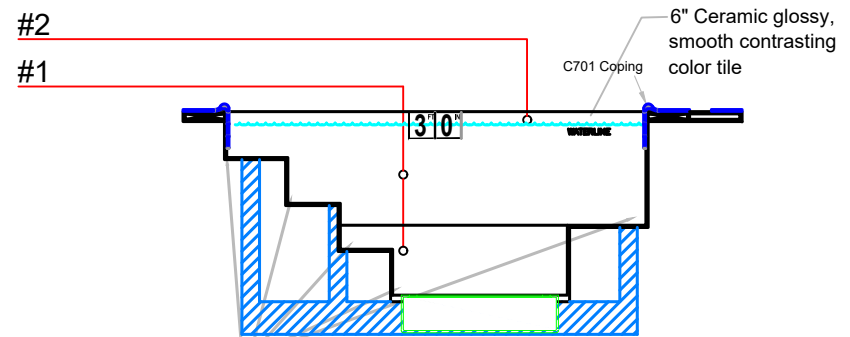
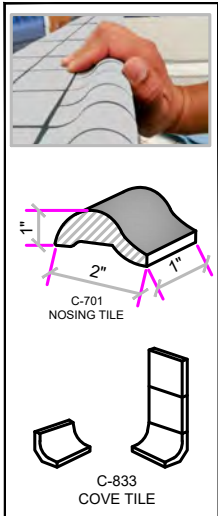
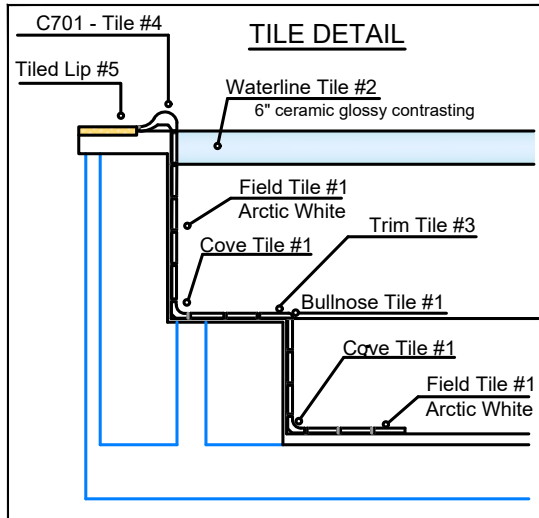
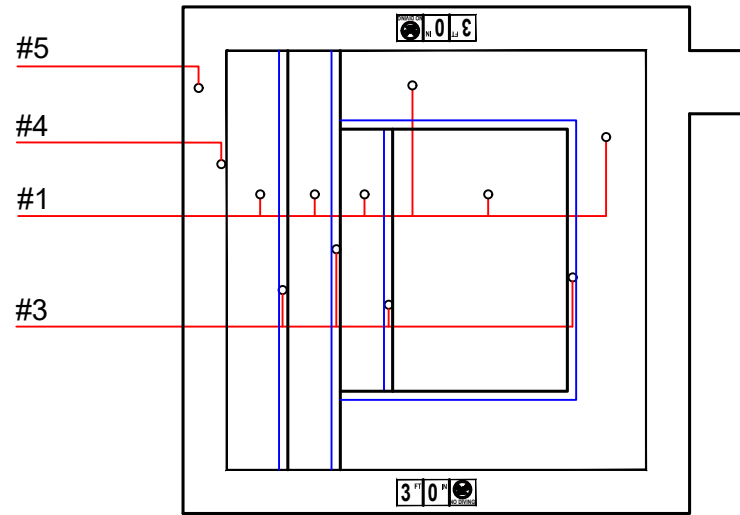

All corners / junctions of the Pool shall be covered.  
 All horizontal surfaces shall be slip resistant tile.



**NOTE: All Piping to be  
Schedule 80**

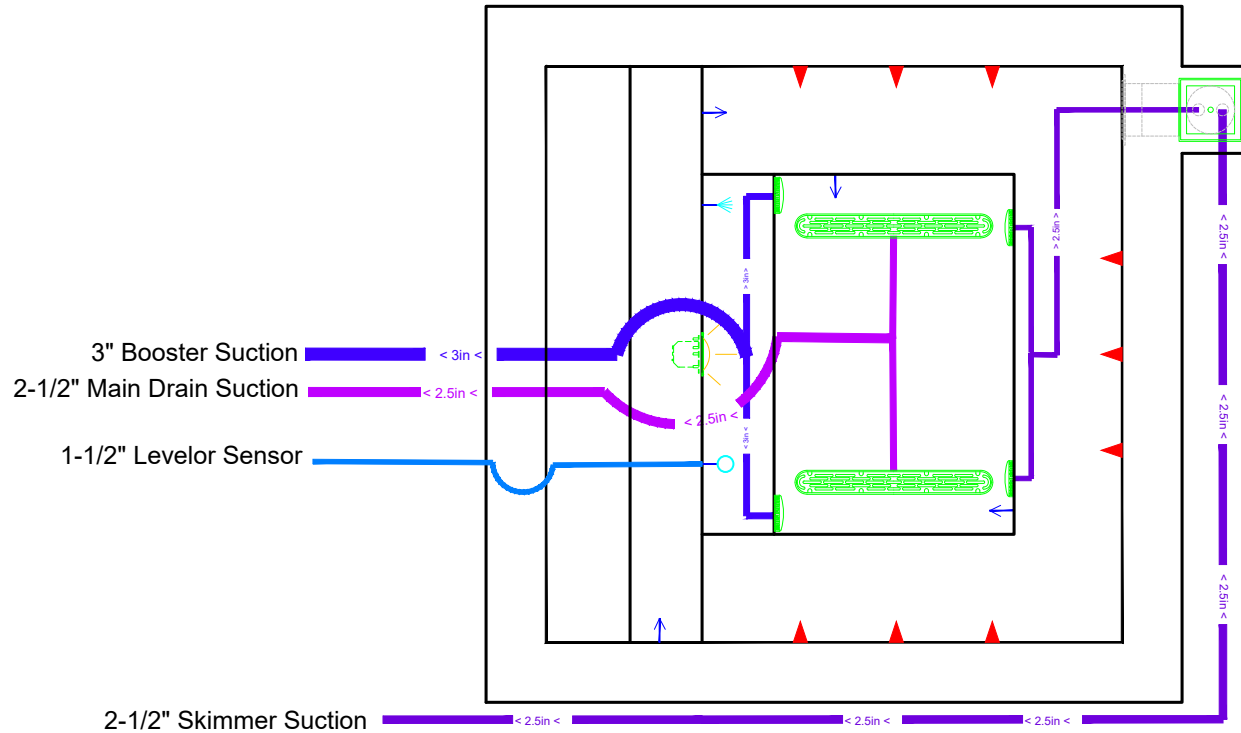

**Detail 1**



Emergency Shut-Off

A single clearly labeled emergency (on/off type) shut off switch which is readily accessible and visible from the spa, that will shut off all filtration, booster, chemical, and blower pumps, is required.

**Detail 2**

**Air Venturi Detail**

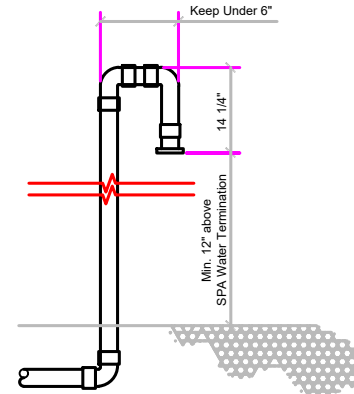

From SPA Jet Venturi Tee - 1-1/2"

**NOTE: All Piping to be Schedule 80**

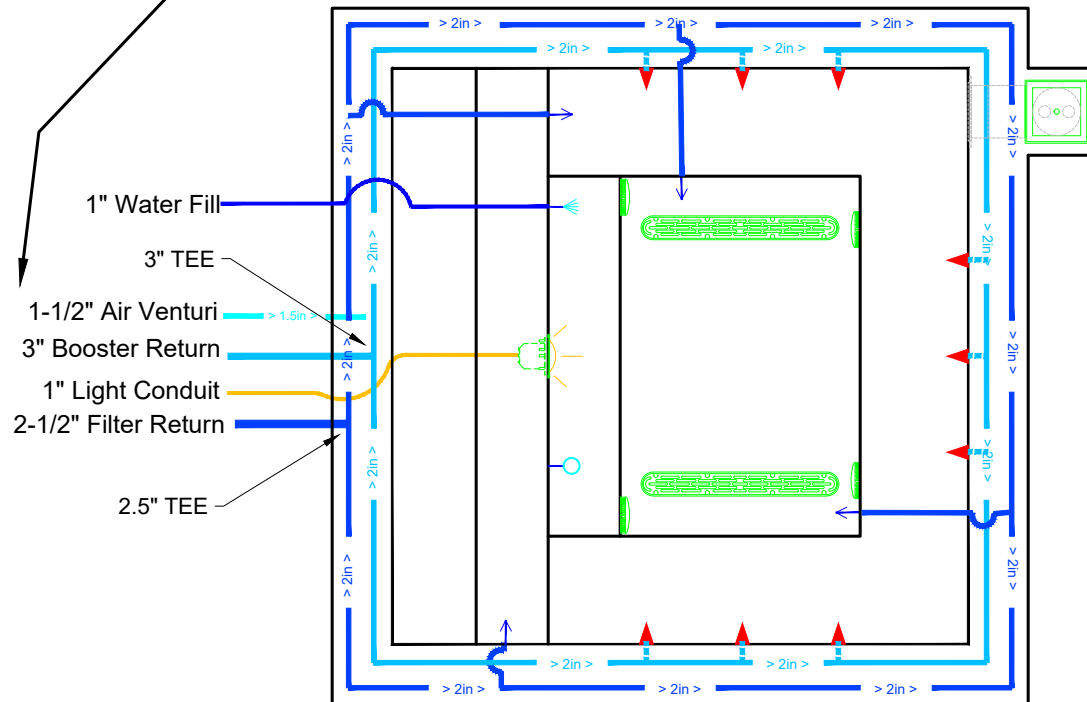

- 1" Water Fill
- 3" TEE
- 1-1/2" Air Venturi
- 3" Booster Return
- 1" Light Conduit
- 2-1/2" Filter Return
- 2.5" TEE



**REQUIRED SIGNS.** All signs shall have clearly legible letters or numbers not less than 4 inches high, unless otherwise noted, fixed to a wall, pole, gate or similar permanent structure in a location visible to all pool users.

**POOL CAPACITY SIGN** - A sign shall indicate the maximum number of pool users permitted for each pool. [In letters and numbers not less than 4 inches high]. The pool user capacity of a spa pool shall be based one pool user for every 10 square feet of pool water surface area. The pool user capacity for all other pools shall be based on one pool user for every 20 square feet of pool water surface area. Pool user capacity requirements do not apply to wading pools or spray grounds

**NO DIVING SIGN.** Signs shall be posted in conspicuous places and shall state, "NO DIVING" at pools with a maximum water depth of 6 feet or less. [In letters not less than 4 inches high].

**NO LIFEGUARD SIGN** - Where no lifeguard service is provided, a sign shall be posted stating, "NO LIFEGUARD ON DUTY." [In letters not less than 4 inches high]. The sign also shall state [in letters not less than 1 inch high], "Children Under the Age of 14 Shall Not Use Pool Without A Parent or Adult Guardian In Attendance."

**ARTIFICIAL RESPIRATION AND CARDIOPULMONARY RESUSCITATION SIGN** - An illustrated diagram with text [not less than 1/4 inch high] of artificial respiration and CPR procedures shall be posted.

**EMERGENCY SIGN** - The emergency telephone number 911, the number of the nearest emergency services, and the name and street address of the pool facility shall be posted. [In letters and numbers not less than 1 inch high].

**SPA WARNING SIGN** - A warning sign for spa pools shall be posted stating, "CAUTION" and shall include the following language [in letters not less than 1 inch high]:

- a. Elderly persons, pregnant women, infants and those with health conditions requiring medical care should consult with a physician before entering the spa.
- b. Unsupervised use by children under the age of 14 is prohibited.
- c. Hot water immersion while under the influence of alcohol, narcotics, drugs or medicines may lead to serious consequences and is not recommended.
- d. Do not use alone.
- e. Long exposure may result in hyperthermia, nausea, dizziness or fainting.

**EMERGENCY SHUT-OFF SWITCH SIGN** - [In letters not less than 1 inch high], a sign shall be posted at the spa emergency shut off switch stating, "EMERGENCY SHUT-OFF SWITCH."

**KEEP CLOSED SIGN** - A sign shall be posted on the exterior side of gates and doors leading into the pool enclosure area stating, "KEEP CLOSED" [In letters not less than 4 inches high].

**DIARRHEA NOTICE SIGN** - A sign [in letters not less than 1 inch high] and in a language or diagram that is clearly stated shall be posted at the entrance area of a public pool which states that persons having currently active diarrhea or who have had active diarrhea within the previous 14 days shall not be allowed to enter the pool water. This sign may be posted with all the other safety signs.



**NESPA ENTERPRISES INC.**

2800 Richter Ave. Ste. C Oroville, CA 95966

Office: (530) 534-9910

E-Mail: [jim@tiledspas.com](mailto:jim@tiledspas.com) Web Site: [www.tiledspas.com](http://www.tiledspas.com)



**"A" Size Sheet**

SCALE  
N/A

DWG TYPE  
SIGNAGE

DWG NAME

DETAILS 2024

DATE  
01/01/2024

SHEET  
PAGE 1 OF 1